

---

# NI-9207

# Specifications

---

2022-10-07

# Contents

NI-9207 Datasheet.....	3
NI-9207 Specifications.....	7



# NI-9207 Datasheet

8

- 8 current and 8 voltage inputs, 500 S/s
- $\pm 20$  mA current inputs,  $\pm 10$  V voltage inputs, 24-bit resolution
- High-Resolution Mode with 50/60 Hz rejection
- 250 V RMS, CAT II, channel-to-earth isolation (spring terminal); 60 V DC, CAT I, channel-to-earth isolation (DSUB)
- DSUB or spring terminal connectivity
- $-40$  °C to  $70$  °C operating range, 5 g vibration, 50 g shock

The NI-9207 combination voltage and current input C Series module has eight channels of  $\pm 20$  mA input and eight channels of  $\pm 10$  V input with built-in 50/60 Hz rejection for noise rejection.

Designed with industrial systems in mind, the NI-9207 combines the two most common inputs to reduce the overall number of modules you need. A system that uses fewer modules has the benefit of leaving slots open for other measurement types or reducing the overall cost and size of the system. The NI-9207 has a standard 37-pin DSUB and 36-pin spring terminal connections for use with cables and connector blocks.

 <p>Kit Contents</p>	<ul style="list-style-type: none"> <li>• NI 9207</li> <li>• NI 9207 Getting Started Guide</li> </ul>
 <p>Accessories</p>	<ul style="list-style-type: none"> <li>• NI 9940 Backshell Connector Kit (Spring Terminal)</li> <li>• NI 9923 Screw-Terminal Block (DSUB)</li> </ul>

## NI C Series Overview



NI provides more than 100 C Series modules for measurement, control, and communication applications. C Series modules can connect to any sensor or bus and allow for high-accuracy measurements that meet the demands of advanced data acquisition and control applications.

- Measurement-specific signal conditioning that connects to an array of sensors and signals
- Isolation options such as bank-to-bank, channel-to-channel, and channel-to-earth ground
- -40 °C to 70 °C temperature range to meet a variety of application and environmental needs
- Hot-swappable

The majority of C Series modules are supported in both CompactRIO and CompactDAQ platforms and you can move modules from one platform to the other with no modification.

## CompactRIO



CompactRIO combines an open-embedded architecture with small size, extreme ruggedness, and C Series modules in a platform powered by the NI LabVIEW reconfigurable I/O (RIO) architecture. Each system contains an FPGA for custom timing, triggering, and processing with a wide array of available modular I/O to meet any embedded application requirement.

## CompactDAQ

CompactDAQ is a portable, rugged data acquisition platform that integrates connectivity, data acquisition, and signal conditioning into modular I/O for directly interfacing to any sensor or signal. Using CompactDAQ with LabVIEW, you can easily customize how you acquire, analyze, visualize, and manage your measurement data.



## Software

### LabVIEW Professional Development System for Windows

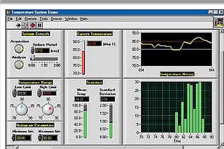

- Use advanced software tools for large project development
- Generate code automatically using DAQ Assistant and Instrument I/O Assistant
- Use advanced measurement analysis and digital signal processing
- Take advantage of open connectivity with DLLs, ActiveX, and .NET objects
- Build DLLs, executables, and MSI installers

### NI LabVIEW FPGA Module

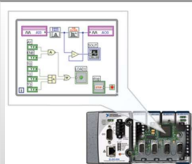

- Design FPGA applications for NI RIO hardware
- Program with the same graphical environment used for desktop and real-time applications
- Execute control algorithms with loop rates up to 300 MHz
- Implement custom timing and triggering logic, digital protocols, and DSP algorithms
- Incorporate existing HDL code and third-party IP including Xilinx IP generator functions
- Purchase as part of the LabVIEW Embedded Control and Monitoring Suite

## NI LabVIEW Real-Time Module

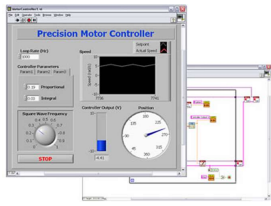

- Design deterministic real-time applications with LabVIEW graphical programming
- Download to dedicated NI or third-party hardware for reliable execution and a wide selection of I/O
- Take advantage of built-in PID control, signal processing, and analysis functions
- Automatically take advantage of multicore CPUs or set processor affinity manually
- Take advantage of real-time OS, development and debugging support, and board support
- Purchase individually or as part of a LabVIEW suite

## Circuitry

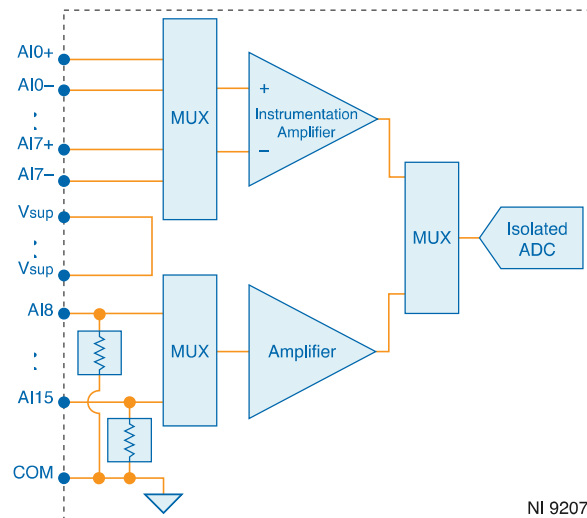

The input signals are scanned, amplified, conditioned, and then sampled by a single 24-bit ADC.

# NI-9207 Specifications

The following specifications are typical for the range -40 °C to 70 °C unless otherwise noted. All voltages are relative to COM unless otherwise noted.

**Caution** Do not operate the NI-9207 in a manner not specified in this document. Product misuse can result in a hazard. You can compromise the safety protection built into the product if the product is damaged in any way. If the product is damaged, return it to NI for repair.

## Input Characteristics

Number of channels	16 analog input channels: 8 voltage and 8 current
ADC resolution	24 bits
Type of ADC	Delta-Sigma
Sampling mode	Scanned
<b>Input range</b>	
<b>Voltage channels</b>	
Minimum	±10.2 V
Typical	±10.4 V
<b>Current channels</b>	
Minimum	±21.5 mA

Typical	±22.0 mA		
Maximum working voltage for analog inputs (signal voltage + common mode voltage), voltage channels only	Each channel must remain within ±10.2 V of common		
<b>Conversion time (per channel)</b>			
High-Resolution Mode	52 ms		
High-Speed Mode	2 ms		
Overvoltage protection, channel-to-COM, all channels	±30 V maximum on one channel at a time		
<b>Vsup pins, current channels only</b>			
Current	2 A maximum		
Voltage	0 to 30 V maximum		
<b>Input impedance</b>			
Voltage channels	>1 GΩ		
Current channels	85 Ω		
Calibrated Measurement Conditions	Channels	Percent of Reading (Gain Error)	Percent of Range <sup>[1]</sup> (Offset Error)
Maximum (-40 °C to 70 °C)	Voltage channels	±0.52%	±0.04%
	Current channels	±0.87%	±0.05%

Table 1. Accuracy



**Input noise****Voltage channels**High-Resolution Mode 16  $\mu\text{Vrms}$ High-Speed Mode 80  $\mu\text{Vrms}$ **Current channels**

High-Resolution Mode 50 nArms

High-Speed Mode 200 nArms

**Stability****Voltage channels**Gain drift  $\pm 21 \text{ ppm}/^\circ\text{C}$ Offset drift  $\pm 14 \mu\text{V}/^\circ\text{C}$ **Current channels**Gain drift  $\pm 43 \text{ ppm}/^\circ\text{C}$ Offset drift  $\pm 30 \text{ nA}/^\circ\text{C}$ CMRR ( $f_{in} = 0 \text{ Hz to } 60 \text{ Hz}$ ), voltage channels only

86 dB

**CMRR, channel-to-earth ground (50/60 Hz)<sup>[2]</sup>**

High-Resolution Mode 160 dB

High-Speed Mode 120 dB

**NMRR (High-Resolution Mode only)**

50 Hz	66 dB
60 Hz	68 dB

## Power Requirements

**Power consumption from chassis**

Active mode	295 mW maximum
Sleep mode	25 $\mu$ W maximum

**Thermal dissipation (at -40 °C)**

Active mode	0.75 W maximum
Sleep mode	0.59 W maximum

## Physical Characteristics

**Spring terminal wiring**

Gauge	copper conductor wire
Wire strip length	of insulation stripped from the end
Temperature rating	
Wires per spring terminal	

**Connector securement**

Securement type	Screw flanges provided
-----------------	------------------------

Torque for screw flanges	
--------------------------	--

## NI-9207 with Spring Terminal Safety Voltages

Connect only voltages that are within the following limits:

### Isolation

Channel-to-channel	None
--------------------	------

### Channel-to-earth ground

Continuous	250 V RMS, Measurement Category II
------------	------------------------------------

Withstand, up to 5,000 m	3,000 V RMS, verified by a 5 s dielectric withstand test
--------------------------	--

## NI-9207 with DSUB Safety Voltages

Connect only voltages that are within the following limits:

### Isolation

Channel-to-channel	None
--------------------	------

### Channel-to-earth ground

Continuous	60 V DC, Measurement Category I
------------	---------------------------------

Withstand, up to 2,000 m	1,000 V RMS, verified by a 5 s dielectric withstand test
--------------------------	--

Withstand, up to 5,000 m	500 V RMS, verified by a 5 s dielectric withstand test
--------------------------	--

## Hazardous Locations

U.S. (UL)	;
Canada (C-UL)	;
Europe (ATEX) and International (IECEX)	

## Safety and Hazardous Locations Standards

This product is designed to meet the requirements of the following electrical equipment safety standards for measurement, control, and laboratory use:

- IEC 61010-1, EN 61010-1
- UL 61010-1, CSA 61010-1
- EN 60079-0:2012, EN 60079-15:2010
- IEC 60079-0: Ed 6, IEC 60079-15; Ed 4
- UL 60079-0; Ed 6, UL 60079-15; Ed 4
- CSA 60079-0:2011, CSA 60079-15:2012

**Note** For UL and other safety certifications, refer to the product label or the [Online Product Certification](#) section.

## Electromagnetic Compatibility

This product meets the requirements of the following EMC standards for electrical equipment for measurement, control, and laboratory use:

- EN 61326-1 (IEC 61326-1): Class A emissions; Industrial immunity
- EN 55011 (CISPR 11): Group 1, Class A emissions
- EN 55022 (CISPR 22): Class A emissions
- EN 55024 (CISPR 24): Immunity

- AS/NZS CISPR 11: Group 1, Class A emissions
- AS/NZS CISPR 22: Class A emissions
- FCC 47 CFR Part 15B: Class A emissions
- ICES-001: Class A emissions

**Note** In the United States (per FCC 47 CFR), Class A equipment is intended for use in commercial, light-industrial, and heavy-industrial locations. In Europe, Canada, Australia and New Zealand (per CISPR 11) Class A equipment is intended for use only in heavy-industrial locations.

**Note** Group 1 equipment (per CISPR 11) is any industrial, scientific, or medical equipment that does not intentionally generate radio frequency energy for the treatment of material or inspection/analysis purposes.

**Note** For EMC declarations and certifications, and additional information, refer to the [Online Product Certification](#) section.

**Caution** For EMC compliance, operate the NI-9207 with DSUB with shielded cables.

## CE Compliance

This product meets the essential requirements of applicable European Directives, as follows:

- 2014/35/EU; Low-Voltage Directive (safety)
- 2014/30/EU; Electromagnetic Compatibility Directive (EMC)
- 2014/34/EU; Potentially Explosive Atmospheres (ATEX)

## Product Certifications and Declarations

Refer to the product Declaration of Conformity (DoC) for additional regulatory compliance information. To obtain product certifications and the DoC for NI

products, visit [ni.com/product-certifications](https://ni.com/product-certifications), search by model number, and click the appropriate link.

## Shock and Vibration

To meet these specifications, you must panel mount the system.

<b>Operating vibration</b>	
Random	5 g RMS, 10 Hz to 500 Hz
Sinusoidal	5 g, 10 Hz to 500 Hz
Operating shock	30 g, 11 ms half sine; 50 g, 3 ms half sine; 18 shocks at 6 orientations

## Environmental

Refer to the manual for the chassis you are using for more information about meeting these specifications.

Operating temperature (IEC 60068-2-1, IEC 60068-2-2)	-40 °C to 70 °C
Storage temperature (IEC 60068-2-1, IEC 60068-2-2)	-40 °C to 85 °C
Ingress protection	IP40
Operating humidity (IEC 60068-2-30)	10% RH to 90% RH, noncondensing
Storage humidity (IEC 60068-2-30)	5% RH to 95% RH, noncondensing
Pollution Degree	2

Maximum altitude	5,000 m
------------------	---------

Indoor use only.

## Environmental Management

NI is committed to designing and manufacturing products in an environmentally responsible manner. NI recognizes that eliminating certain hazardous substances from our products is beneficial to the environment and to NI customers.

For additional environmental information, refer to the **Engineering a Healthy Planet** web page at [ni.com/environment](http://ni.com/environment). This page contains the environmental regulations and directives with which NI complies, as well as other environmental information not included in this document.

## EU and UK Customers

-  **Waste Electrical and Electronic Equipment (WEEE)**—At the end of the product life cycle, all NI products must be disposed of according to local laws and regulations. For more information about how to recycle NI products in your region, visit [ni.com/environment/weee](http://ni.com/environment/weee).

## 电子信息产品污染控制管理办法（中国 RoHS）

-  **中国 RoHS**— NI 符合中国电子信息产品中限制使用某些有害物质指令(RoHS)。关于 NI 中国 RoHS 合规性信息，请登录 [ni.com/environment/rohs\\_china](http://ni.com/environment/rohs_china)。(For information about China RoHS compliance, go to [ni.com/environment/rohs\\_china](http://ni.com/environment/rohs_china).)

## Calibration

You can obtain the calibration certificate and information about calibration services for the NI-9207 at [ni.com/calibration](http://ni.com/calibration).

Calibration interval	2 years
----------------------	---------

<sup>1</sup> Range equals 10.4 V for voltage channels and 22.0 mA for current channels.

<sup>2</sup> Voltage channel of NI-9207 with spring terminal only.