NI-9775

Specifications

2022-10-07

Contents

NI 9775 Datasheet..... 3

NI 9775 Datasheet



- BNC connectivity
- High-speed measurements up to 20 MS/s/ch at 68 dB SNR
- High-resolution measurements up to 5 MS/s/ch at 74 dB SNR
- 14-bit resolution
- Built-in analog reference trigger
- 128 Mbits onboard memory

The NI-9775, a 4-channel digitizer, can measure transient phenomenon like faults in electrical transmission lines from lightning strikes or structural failure events at 20 MS/s/ch. The module's store and forward architecture allows up to 128 Mbits of measurement data to be sent back to the controller and analyzed. The module has a built-in analog reference trigger, or you can use CompactRIO and LabVIEW FPGA to develop an advanced trigger based on low-speed streaming data for added flexibility.

	Kit Contents	<ul style="list-style-type: none"> • NI 9775 • NI 9775 Getting Started Guide
	Accessories	<ul style="list-style-type: none"> • BNC Male to BNC Male Cables

NI C Series Overview



NI provides more than 100 C Series modules for measurement, control, and communication applications. C Series modules can connect to any sensor or bus and allow for high-accuracy measurements that meet the demands of advanced data acquisition and control applications.

- Measurement-specific signal conditioning that connects to an array of sensors and signals
- Isolation options such as bank-to-bank, channel-to-channel, and channel-to-earth ground
- -40 °C to 70 °C temperature range to meet a variety of application and environmental needs
- Hot-swappable

The majority of C Series modules are supported in both CompactRIO and CompactDAQ platforms and you can move modules from one platform to the other with no modification.

CompactRIO



CompactRIO combines an open-embedded architecture with small size, extreme ruggedness, and C Series modules in a platform powered by the NI LabVIEW reconfigurable I/O (RIO) architecture. Each system contains an FPGA for custom timing, triggering, and processing with a wide array of available modular I/O to meet any embedded application requirement.

CompactDAQ

CompactDAQ is a portable, rugged data acquisition platform that integrates connectivity, data acquisition, and signal conditioning into modular I/O for directly interfacing to any sensor or signal. Using CompactDAQ with LabVIEW, you can easily customize how you acquire, analyze, visualize, and manage your measurement data.



Software

LabVIEW Professional Development System for Windows



- Use advanced software tools for large project development
- Generate code automatically using DAQ Assistant and Instrument I/O Assistant
- Use advanced measurement analysis and digital signal processing
- Take advantage of open connectivity with DLLs, ActiveX, and .NET objects
- Build DLLs, executables, and MSI installers

NI LabVIEW FPGA Module

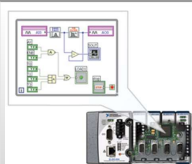

- Design FPGA applications for NI RIO hardware
- Program with the same graphical environment used for desktop and real-time applications
- Execute control algorithms with loop rates up to 300 MHz
- Implement custom timing and triggering logic, digital protocols, and DSP algorithms
- Incorporate existing HDL code and third-party IP including Xilinx IP generator functions
- Purchase as part of the LabVIEW Embedded Control and Monitoring Suite

NI LabVIEW Real-Time Module

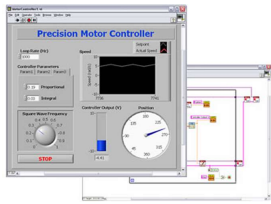

- Design deterministic real-time applications with LabVIEW graphical programming
- Download to dedicated NI or third-party hardware for reliable execution and a wide selection of I/O
- Take advantage of built-in PID control, signal processing, and analysis functions
- Automatically take advantage of multicore CPUs or set processor affinity manually
- Take advantage of real-time OS, development and debugging support, and board support
- Purchase individually or as part of a LabVIEW suite

Circuitry

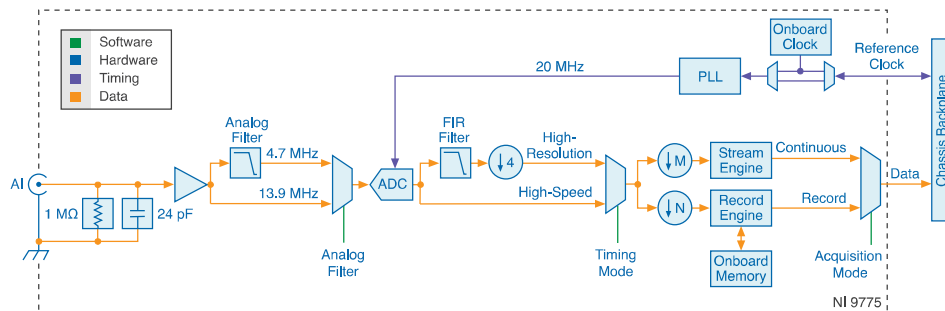

Note The diagram shows one channel inside the NI-9775.

- The shell of the BNC connects to CHASSIS GND.
- The four channels of the NI-9775 share the clock circuit and operate simultaneously.
- The NI-9775 has two separate data engines operating simultaneously for each channel: the continuous stream engine and triggered record engine.

- The module waits for a trigger event, fills the circular buffer with the configured set of data (called a record), then streams the entire record from the module to the chassis.
- The analog filter allows you to select 10 MHz or 5 MHz bandwidth.
- The software-selectable digital decimation filter improves resolution and alias rejection.
- The ADC samples the analog signal continuously at 20 MS/s.

Timing Modes

The NI-9775 has two timing modes: high-speed and high-resolution. High-speed mode turns off the digital decimation filter on all channels and enables you to set the analog filter per channel. High-resolution mode turns on both the analog filter and digital decimation filter for all channels.

Acquisition Modes

The NI-9775 has three acquisition modes: continuous mode, record mode, and advanced mode. In continuous mode, the NI-9775 transfers real-time data to the chassis at an aggregate rate of 4 MS/s across all channels. In record mode, the NI-9775 stores samples into onboard memory at up to 20 MS/s then transfers the data to the chassis at a slower rate. In advanced mode, the NI-9775 combines the functionality of continuous mode and record mode to enable more complex triggering schemes based on the continuous data.

Note Advanced mode is only available on CompactRIO systems.

Related reference

- [Horizontal](#)

Map

NI-9775 Specifications

The following specifications are typical for the range -40 °C to 70 °C unless otherwise noted.

Caution Do not operate the NI-9775 in a manner not specified in this document. Product misuse can result in a hazard. You can compromise the safety protection built into the product if the product is damaged in any way. If the product is damaged, return it to NI for repair.

Input Characteristics

Number of channels	4 (simultaneously sampled)
Input type	Reference single-ended
Input impedance	1 M Ω
Input capacitance	24 pF
Input coupling	DC
Input range	
Nominal	± 10 V
Typical	± 11.3 V
Minimum	± 10.04 V
ADC resolution	14 bits

Overvoltage protection	± 30 V DC, safe operating area
------------------------	------------------------------------

Figure 1. Safe Operating Area

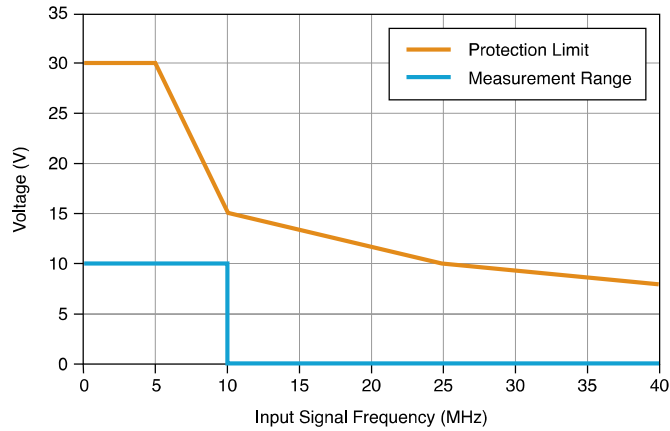

Measurement Conditions		Percent of Reading (Gain Error)	Percent of Range ^[1] (Offset Error)
Calibrated	Maximum (-40 °C to 70 °C)	$\pm 1.7\%$	$\pm 0.49\%$
	Typical (25 °C, ± 5 °C)	$\pm 0.32\%$	$\pm 0.08\%$
Uncalibrated ^[2]	Maximum (-40 °C to 70 °C)	$\pm 4.0\%$	$\pm 4.0\%$
	Typical (25 °C, ± 5 °C)	$\pm 1.7\%$	$\pm 1.8\%$

Table 1. DC Accuracy

DC gain drift	± 140 ppm/ $^{\circ}$ C
DC offset drift	± 0.34 mV/ $^{\circ}$ C
AC amplitude accuracy	± 0.25 dB at 50 kHz
AC amplitude drift	± 172 ppm/ $^{\circ}$ C
Channel-to-channel crosstalk	< -90 dB at 5 MHz
Timing modes (software-selectable)	High-speed, high-resolution

Analog filter (software-selectable)	6 th order low-pass Bessel
Analog filter -3 dB bandwidth	
High-speed mode with analog filter disabled	13.9 MHz
High-speed mode with analog filter enabled	4.7 MHz
High-resolution mode	2.36 MHz
Alias rejection in high-resolution mode	45 dB at 5 MS/s only

Figure 2. Frequency Response in High-Speed Mode with Analog Filter Disabled

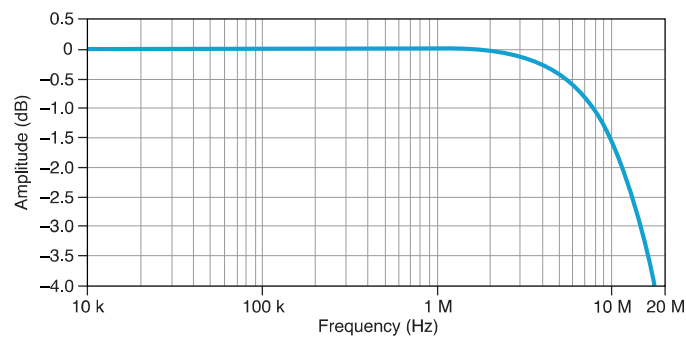

Figure 3. Frequency Response in High-Speed Mode with Analog Filter Enabled

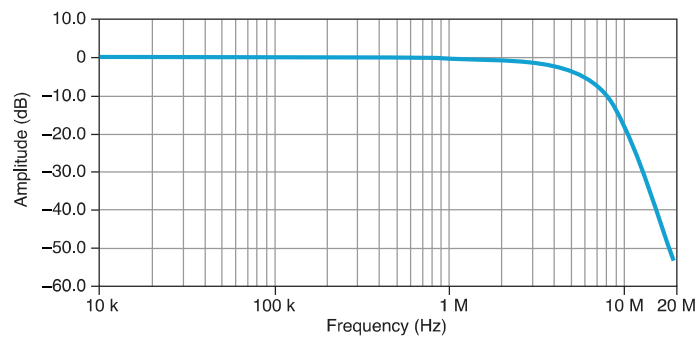

Figure 4. Frequency Response in High-Resolution Mode

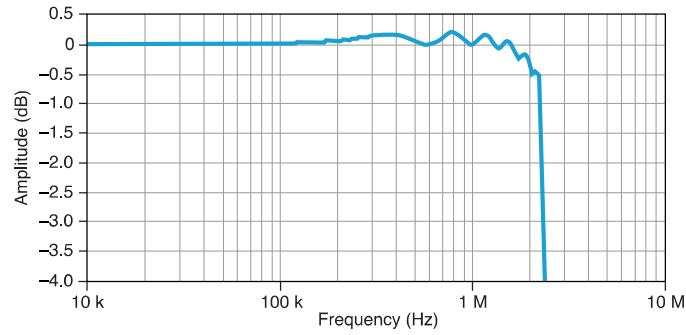

Figure 5. Idle Channel FFT in High-Speed Mode with Analog Filter Disabled (20 MS/s, 32,768 point FFT)

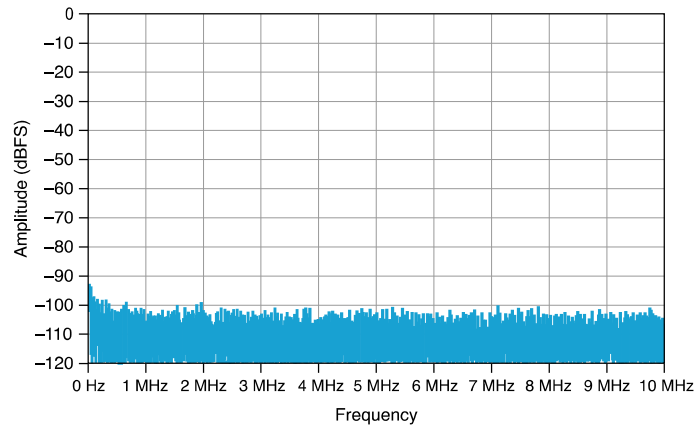

Figure 6. Idle Channel FFT in High-Resolution Mode (1 MS/s, 32,768 point FFT)

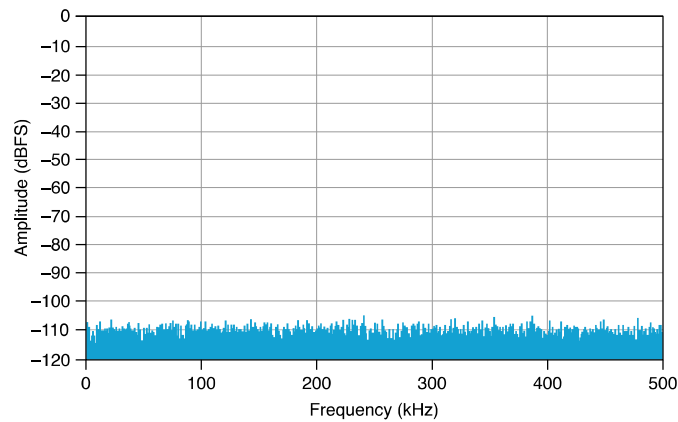

Figure 7. Step Response

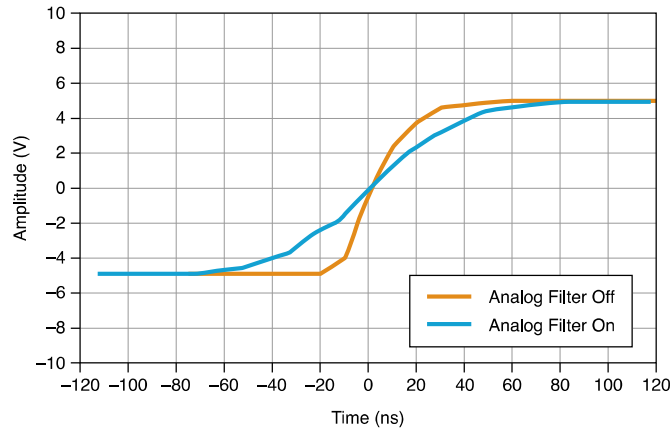
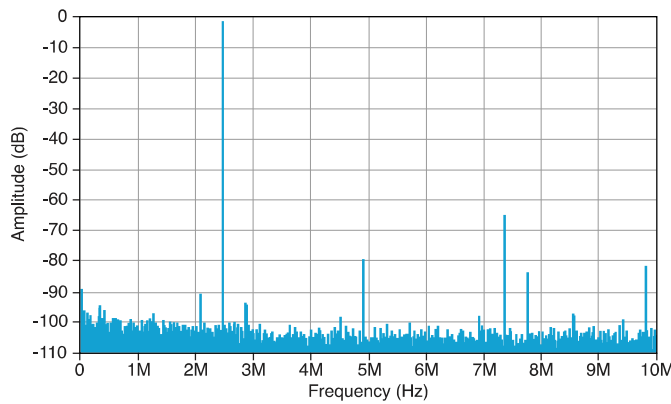

Figure 8. Single-Tone Spectrum at (-1 dB FS, 2.45 MHz)



Spurious free dynamic range (-60 dB FS input)

High-speed mode at 2.45 MHz	89 dB FS
High-resolution mode at 100 kHz	94 dB FS

Input to trigger delay

High-speed mode with analog filter disabled	863 ns
High-speed mode with analog filter enabled	950 ns
High-resolution mode	4.62 μ s

Input delay (Continuous Mode)		
High-speed mode with analog filter disabled		913 ns
High-speed mode with analog filter enabled		999 ns
High-resolution mode		4.67 μ s
Noise		
High-speed mode	2.8 mV RMS	
High-resolution mode	1.4 mV RMS	
Effective number of bits		
High-speed mode		11 bits
High-resolution mode		12 bits
Signal-to-Noise ratio		
High-speed mode	68 dB at 2.45 MHz	
High-resolution mode	74 dB at 100 kHz	
Total harmonic distortion at -1 dB FS input		
High-speed mode with analog filter disabled at 2.45 MHz		-62 dB FS
High-speed mode with analog filter enabled at 1 MHz		-69 dB FS
High-resolution mode at 100 kHz and		-75 dB FS
Channel-to-channel skew		

Analog filter disabled	1.5 ns
Analog filter enabled	12.7 ns
LSB weight	1.385 mV/LSB

Horizontal

Sample clock source	20 MHz PLL
Maximum sample rate in record mode	
High-speed mode	20 MS/s
High-resolution mode	5 MS/s

Figure 9. Phase Noise

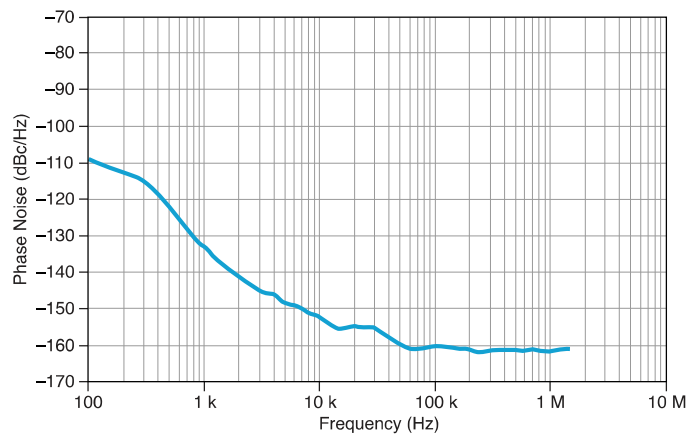

Timebase frequency	20 MHz
Timebase accuracy	±50 ppm
PLL reference clock source	

Internal master timebase	12.8 MHz
Chassis OCLK	12.8 MHz

Data Rate in Record Mode

$$\frac{20 \text{ MS/s}}{N}$$

Where

- $N \in \{1, 2, 3, 4, 5, \dots, 65,535\}$ for high-speed mode
- $N \in \{4, 8, 12, 16, 20, \dots, 65,532\}$ for high-resolution mode

Data Rate in Continuous Mode

$$\frac{20 \text{ MS/s}}{M}$$

Where

- $M \in \{5, 6, 7, 8, 9, \dots, 65,535\}$ with one channel enabled for high-speed mode
- $M \in \{8, 12, 16, 20, 24, \dots, 65,532\}$ with one channel enabled for high-resolution mode
- $M \in \{10, 11, 12, 13, 14, \dots, 65,535\}$ with two channels enabled for high-speed mode
- $M \in \{12, 16, 20, 24, 28, \dots, 65,532\}$ with two channels enabled for high-resolution mode
- $M \in \{15, 16, 17, 18, 19, \dots, 65,535\}$ with three channels enabled for high-speed mode
- $M \in \{16, 20, 24, 28, 32, \dots, 65,532\}$ with three channels enabled for high-resolution mode
- $M \in \{20, 21, 22, 23, 24, \dots, 65,535\}$ with four channels enabled for high-speed mode
- $M \in \{20, 24, 28, 32, 36, \dots, 65,532\}$ with four channels enabled for high-resolution mode

Trigger

Supported trigger modes	Start and reference
Trigger types	Analog edge, digital edge, and software
Trigger sources	AI0 to AI3 and chassis backplane
Dead time	0 samples

Analog Edge Trigger

Trigger sources	AI0 to AI3
Settings	Level, slope, and hysteresis
Trigger uncertainty	≤ 1 sample
Rearm time	1 sample minimum

Waveform Specifications

Onboard memory size	128 Mbits
Minimum record length	16 samples
Minimum number of pre-trigger samples	
CompactRIO	1
CompactDAQ	2

Minimum number of post-trigger samples	
CompactRIO	1
CompactDAQ	2
Maximum number of records	32 records
Maximum number of samples per record ^[3]	$\frac{2 * \left[\left(\frac{2^{22}}{\text{Number of records}} \right) - 1 \right]}{\text{Number of channels}}$
Record data transfer rate	
Maximum ^[4]	4.7 MS/s
Typical	4 MS/s

Power Requirements

Power consumed from chassis	
Active mode	0.9 W maximum
Sleep mode	52.5 μ W maximum
Thermal dissipation (at 70 °C)	
Active mode	1.06 W maximum
Sleep mode	3.65 mW maximum

Safety Voltages

Connect only voltages that are within Measurement Category O.

Isolation	
Channel-to-channel	None
Channel-to-earth ground	None

Physical Characteristics

Dimensions	Visit ni.com/dimensions and search by module number.
Weight	172 g

Hazardous Locations

U.S. (UL)	Class I, Division 2, Groups A, B, C, D, T4; Class I, Zone 2, AEx nA IIC T4 Gc
Canada (C-UL)	Class I, Division 2, Groups A, B, C, D, T4; Ex nA IIC T4 Gc
Europe (ATEX) and International (IECEX)	Ex nA IIC T4 Gc DEMKO 12 ATEX 1202658X IECEX UL 14.0089X

Safety Compliance and Hazardous Locations Standards

This product is designed to meet the requirements of the following electrical equipment safety standards for measurement, control, and laboratory use:

- IEC 61010-1, EN 61010-1
- UL 61010-1, CSA C22.2 No. 61010-1
- EN 60079-0, EN 60079-7
- IEC 60079-0, IEC 60079-7
- UL 60079-0, UL 60079-7
- CSA C22.2 No. 60079-0, CSA C22.2 No. 60079-7

Note For safety certifications, refer to the product label or the [Product Certifications and Declarations](#) section.

Electromagnetic Compatibility

CE Compliance

This product meets the essential requirements of applicable European Directives, as follows:

- 2014/35/EU; Low-Voltage Directive (safety)
- 2014/30/EU; Electromagnetic Compatibility Directive (EMC)
- 2014/34/EU; Potentially Explosive Atmospheres (ATEX)

Product Certifications and Declarations

Refer to the product Declaration of Conformity (DoC) for additional regulatory compliance information. To obtain product certifications and the DoC for NI products, visit ni.com/product-certifications, search by model number, and click the appropriate link.

Shock and Vibration

To meet these specifications, you must panel mount the system.

Operating vibration

Random	5 g RMS, 10 Hz to 500 Hz
Sinusoidal	5 g, 10 Hz to 500 Hz
Operating shock	30 g, 11 ms half sine; 50 g, 3 ms half sine; 18 shocks at 6 orientations

Environmental

Refer to the manual for the chassis you are using for more information about meeting these specifications.

Operating temperature (IEC 60068-2-1, IEC 60068-2-2)	-40 °C to 70 °C
Storage temperature (IEC 60068-2-1, IEC 60068-2-2)	-40 °C to 85 °C
Ingress protection	IP40
Operating humidity (IEC 60068-2-30)	10% RH to 90% RH, noncondensing
Storage humidity (IEC 60068-2-30)	5% RH to 95% RH, noncondensing
Pollution Degree	2
Maximum altitude	5,000 m

Indoor use only.

Environmental Management

NI is committed to designing and manufacturing products in an environmentally responsible manner. NI recognizes that eliminating certain hazardous substances from our products is beneficial to the environment and to NI customers.

For additional environmental information, refer to the **Engineering a Healthy Planet** web page at ni.com/environment. This page contains the environmental regulations and directives with which NI complies, as well as other environmental information not included in this document.

EU and UK Customers

-  **Waste Electrical and Electronic Equipment (WEEE)**—At the end of the product life cycle, all NI products must be disposed of according to local laws and regulations. For more information about how to recycle NI products in your region, visit ni.com/environment/weee.

电子信息产品污染控制管理办法（中国 RoHS）

-  **中国 RoHS**— NI 符合中国电子信息产品中限制使用某些有害物质指令(RoHS)。关于 NI 中国 RoHS 合规性信息，请登录 ni.com/environment/rohs_china。(For information about China RoHS compliance, go to ni.com/environment/rohs_china.)

Calibration

You can obtain the calibration certificate and information about calibration services for the NI-9775 at ni.com/calibration.

Calibration interval	1 year
----------------------	--------

¹ Range equals 10 V for absolute accuracy calculations.

² Uncalibrated accuracy refers to the accuracy achieved when acquiring in raw or unscaled modes where the calibration constants stored in the module are not applied to the data.

³ The maximum number of samples per record is different for CompactRIO systems.

⁴ With all four channels enabled.