NI-9212

Specifications

2022-10-07

Contents



NI 9212 with NI TB-9212.	3
NI-9212 Specifications.	9

NI 9212 with NI TB-9212



- Isothermal terminal block for measurement accuracy up to 0.29 °C
- 50 Hz/60 Hz noise rejection
- Up to 0.01 °C measurement sensitivity
- 250 Vrms, CAT II channel-to-channel isolation (TB-9212 with screw terminal); 60 VDCCAT I channel-to-channel isolation (TB-9212 with mini TC)

The NI-9212 is a channel-to-channel isolated thermocouple input module for NI CompactDAQ and CompactRIO systems. The NI-9212 provides accuracies similar to the NI 9214, eliminating the need to choose between channel-to-channel isolation and accuracy. You can use the NI-9212 in a variety of applications that are not conducive for bank-isolated channels such as white goods testing, in-vehicle data logging, battery stack testing, as well as various other noisy industrial environments.

 <p>Kit Contents</p>	<ul style="list-style-type: none"> • NI 9212 • NI TB-9212 Isothermal Terminal Block (Screw or Mini-TC) • NI 9212 Getting Started Guide
 <p>Accessories</p>	<ul style="list-style-type: none"> • Spare NI TB-9212 Isothermal Terminal Block (Screw or Mini TC) • Thermocouple Connectors

NI C Series Overview



NI provides more than 100 C Series modules for measurement, control, and communication applications. C Series modules can connect to any sensor or bus and allow for high-accuracy measurements that meet the demands of advanced data acquisition and control applications.

- Measurement-specific signal conditioning that connects to an array of sensors and signals
- Isolation options such as bank-to-bank, channel-to-channel, and channel-to-earth ground
- -40 °C to 70 °C temperature range to meet a variety of application and environmental needs
- Hot-swappable

The majority of C Series modules are supported in both CompactRIO and CompactDAQ platforms and you can move modules from one platform to the other with no modification.

CompactRIO



CompactRIO combines an open-embedded architecture with small size, extreme ruggedness, and C Series modules in a platform powered by the NI LabVIEW reconfigurable I/O (RIO) architecture. Each system contains an FPGA for custom timing, triggering, and processing with a wide array of available modular I/O to meet any embedded application requirement.

CompactDAQ

CompactDAQ is a portable, rugged data acquisition platform that integrates connectivity, data acquisition, and signal conditioning into modular I/O for directly interfacing to any sensor or signal. Using CompactDAQ with LabVIEW, you can easily customize how you acquire, analyze, visualize, and manage your measurement data.



Software

LabVIEW Professional Development System for Windows

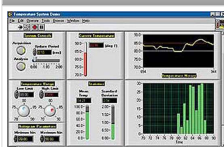

- Use advanced software tools for large project development
- Generate code automatically using DAQ Assistant and Instrument I/O Assistant
- Use advanced measurement analysis and digital signal processing
- Take advantage of open connectivity with DLLs, ActiveX, and .NET objects
- Build DLLs, executables, and MSI installers

NI LabVIEW FPGA Module

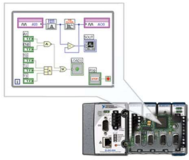

- Design FPGA applications for NI RIO hardware
- Program with the same graphical environment used for desktop and real-time applications
- Execute control algorithms with loop rates up to 300 MHz
- Implement custom timing and triggering logic, digital protocols, and DSP algorithms
- Incorporate existing HDL code and third-party IP including Xilinx IP generator functions
- Purchase as part of the LabVIEW Embedded Control and Monitoring Suite

NI LabVIEW Real-Time Module

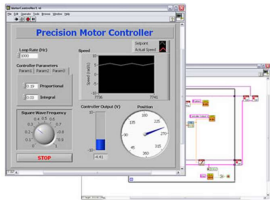

- Design deterministic real-time applications with LabVIEW graphical programming
- Download to dedicated NI or third-party hardware for reliable execution and a wide selection of I/O
- Take advantage of built-in PID control, signal processing, and analysis functions
- Automatically take advantage of multicore CPUs or set processor affinity manually
- Take advantage of real-time OS, development and debugging support, and board support
- Purchase individually or as part of a LabVIEW suite

NI-9212 Circuitry

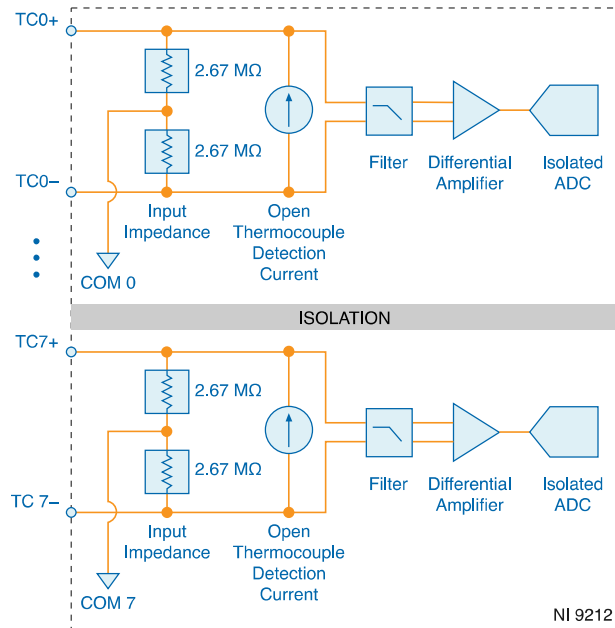

- Each channel simultaneously passes through a filtered, differential amplifier before being sampled by a 24-bit ADC.
- The NI-9212 provides channel-to-channel isolation.

Open Thermocouple Detection

Each channel has an open thermocouple detection (OTD) circuit, which consists of a current source between the TC+ and TC- terminals. If an open thermocouple is connected to the channel, the current source forces a full-scale voltage across the terminals.

Input Impedance

Each channel has a resistor that produces an input impedance between the TC and COM terminals. The gain and offset errors resulting from the source impedance of connected thermocouples are negligible for most applications. Thermocouples with a higher lead resistance can introduce more significant errors.

Timing Modes

The NI-9212 supports high-resolution, best 50 Hz rejection, best 60 Hz rejection, and high-speed timing modes. High-resolution timing mode optimizes accuracy and noise and rejects power line frequencies. Best 50 Hz rejection optimizes 50 Hz noise rejection. Best 60 Hz rejection optimizes 60 Hz noise rejection. High-speed timing mode optimizes sample rate and signal bandwidth.

Thermocouple Measurement Accuracy

Thermocouple measurement errors depend partly on the following factors:

- Type of thermocouple
- Accuracy of the thermocouple
- Temperature that you are measuring
- Resistance of the thermocouple wires
- Cold-junction temperature

NI-9212 Specifications

The following specifications are typical for the range -40 °C to 70 °C unless otherwise noted. The specifications are for the NI-9212 used in conjunction with an TB-9212.

Caution Do not operate the NI-9212 in a manner not specified in this document. Product misuse can result in a hazard. You can compromise the safety protection built into the product if the product is damaged in any way. If the product is damaged, return it to NI for repair.

Warm-up time ^[1]	15 minutes
-----------------------------	------------

Input Characteristics

Number of channels	
NI 9212	8 isolated thermocouple channels
TB-9212	2 internal cold-junction compensation channels
ADC resolution	24 bits
Type of ADC	Delta-Sigma
Sampling mode	Simultaneous
Voltage measurement range	±78.125 mV
Temperature measurement ranges	Works over temperature ranges defined by NIST (J, K, T, E, N, B, R, and S thermocouple types)

Conversion time (simultaneously sampled)

Timing Mode	Conversion Time (ms)	Sample Rate (S/s)
High-resolution	550	1.8
Best 50 Hz rejection	140	7.1
Best 60 Hz rejection	120	8.3
High-speed	10.5	95

Common-mode voltage range

Channel-to-channel See the [Isolation Voltages](#) section for more information

Channel-to-earth ground See the [Isolation Voltages](#) section for more information

Common-mode rejection ratio (0 Hz to 1,000 Hz)**Rejection of channel-to-channel common mode voltages**

High-resolution, best 50 Hz rejection, best 60 Hz rejection 160 dB

High-speed 145 dB

Rejection of channel-to-earth ground common mode voltages

High-resolution, best 50 Hz rejection, best 60 Hz rejection 145 dB

High-speed 125 dB

Thermocouple signal input bandwidth

High-resolution 1.0 Hz

Best 50 Hz rejection 4.0 Hz

Best 60 Hz rejection 4.7 Hz

High-speed	31 Hz
Open thermocouple settling time	0.75 s
Noise rejection	
High-resolution (at 50/60 Hz)	74 dB
Best 50 Hz rejection	80 dB
Best 60 Hz rejection	85 dB
Overvoltage protection	± 30 V between TC+ and TC-
Differential input impedance	5 M Ω
Input noise	
High-resolution, RMS	85 nVrms
Best 50 Hz rejection, best 60 Hz rejection, RMS	150 nVrms
High-speed, RMS	1 μ Vrms
Gain error	0.02% typical at 23 °C \pm 5 °C, 0.12% maximum at -40 °C to 70 °C
Offset error	5 μ V typical at 23 °C \pm 5 °C, 14 μ V maximum at -40 °C to 70 °C
Offset error from source impedance with OTD	Add 37.4 nV per Ω at 23 °C \pm 5 °C
Input OTD bias current	37.4 nA at 23 °C \pm 5 °C

Input OTD bias current drift	± 12 pA/°C maximum
Cold-junction compensation accuracy	
TB-9212 with screw terminal	
23 °C \pm 5 °C	0.25 °C typical
-20 °C to 70 °C	0.6 °C maximum
-40 °C to 70 °C	1.1 °C maximum
TB-9212 with mini TC	
23 °C \pm 5 °C	0.6 °C typical
-20 °C to 70 °C	1.2 °C maximum
-40 °C to 70 °C	1.7 °C maximum

Temperature Measurement Accuracy

Measurement sensitivity^[2]	
High-resolution	
Types J, K, T, E, N	0.01 °C
Types R, S	0.02 °C
Type B	0.03 °C
Best 50/60 Hz rejection	
Types J, K, T, E, N	0.02 °C

Types R, S	0.04 °C
Type B	0.06 °C
High-speed	
Types J, K, T, E	0.05 °C
Type N	0.07 °C
Types R, S	0.18 °C
Type B	0.26 °C

The following thermocouple measurement tables and graphs show the module accuracy for each thermocouple type at 0 V common mode voltage. The tables include all measurement errors of the module and terminal block including RMS noise. The tables do not include the accuracy of the thermocouple itself.

Temperature	High-Resolution/Best 50 Hz Rejection/Best 60 Hz Rejection			High-Speed		
	Typical	Maximum		Typical	Maximum	
	23 °C ± 5 °C	-20 °C to 70 °C	-40 °C to 70 °C	23 °C ± 5 °C	-20 °C to 70 °C	-40 °C to 70 °C
-100 °C	0.57	1.69	1.69	0.59	1.83	2.26
0 °C	0.45	1.27	1.36	0.46	1.37	1.82
100 °C	0.39	1.04	1.29	0.41	1.13	1.70
300 °C	0.36	1.08	1.30	0.38	1.17	1.69
500 °C	0.38	1.25	1.50	0.40	1.31	1.89
700 °C	0.38	1.43	1.58	0.41	1.51	1.91
900 °C	0.41	1.68	1.82	0.44	1.76	2.15
1100 °C	0.46	1.96	2.15	0.50	2.05	2.54

Table 1. TB-9212 with Screw Terminal Thermocouple Type J/N Measurement Accuracy (°C)

Temperature	High-Resolution/Best 50 Hz Rejection/Best 60 Hz Rejection			High-Speed		
	Typical	Maximum		Typical	Maximum	
	23 °C ± 5 °C	-20 °C to 70 °C	-40 °C to 70 °C	23 °C ± 5 °C	-20 °C to 70 °C	-40 °C to 70 °C
-100 °C	1.02	2.52	2.52	1.05	2.65	2.97
0 °C	0.81	1.94	1.94	0.83	2.04	2.40
100 °C	0.71	1.62	1.79	0.73	1.71	2.20
300 °C	0.69	1.61	1.81	0.70	1.68	2.20
500 °C	0.71	1.82	2.01	0.73	1.89	2.40
700 °C	0.67	1.88	2.02	0.69	1.96	2.37
900 °C	0.69	2.12	2.24	0.72	2.21	2.60
1100 °C	0.78	2.51	2.64	0.81	2.58	3.04

Table 2. TB-9212 with Mini TC Thermocouple Type J/N Measurement Accuracy (°C)

Temperature	High-Resolution/Best 50 Hz Rejection/Best 60 Hz Rejection			High-Speed		
	Typical	Maximum		Typical	Maximum	
	23 °C ± 5 °C	-20 °C to 70 °C	-40 °C to 70 °C	23 °C ± 5 °C	-20 °C to 70 °C	-40 °C to 70 °C
-100 °C	0.51	1.46	1.48	0.53	1.56	2.03
0 °C	0.38	1.01	1.12	0.39	1.09	1.55
100 °C	0.37	0.90	1.19	0.38	1.00	1.60
300 °C	0.40	1.13	1.40	0.41	1.21	1.82
700 °C	0.45	1.59	1.84	0.48	1.68	2.26
900 °C	0.50	1.91	2.15	0.54	2.00	2.60
1100 °C	0.56	2.26	2.50	0.60	2.36	2.98
1400 °C	0.67	2.84	3.10	0.72	2.96	3.63

Table 3. TB-9212 with Screw Terminal Thermocouple Type K Measurement Accuracy (°C)

Temperature	High-Resolution/Best 50 Hz Rejection/Best 60 Hz Rejection			High-Speed		
	Typical	Maximum		Typical	Maximum	
	23 °C ± 5 °C	-20 °C to 70 °C	-40 °C to 70 °C	23 °C ± 5 °C	-20 °C to 70 °C	-40 °C to 70 °C
-100 °C	0.98	2.27	2.27	1.00	2.37	2.75
0 °C	0.73	1.64	1.68	0.75	1.72	2.10
100 °C	0.71	1.51	1.73	0.73	1.58	2.14
300 °C	0.74	1.73	1.94	0.76	1.81	2.35
700 °C	0.79	2.19	2.37	0.82	2.27	2.79
900 °C	0.86	2.53	2.70	0.89	2.62	3.15
1100 °C	0.94	2.92	3.09	0.98	3.02	3.56
1400 °C	1.09	3.57	3.75	1.14	3.70	4.28

Table 4. TB-9212 with Mini TC Thermocouple Type K Measurement Accuracy (°C)

Temperature	High-Resolution/Best 50 Hz Rejection/Best 60 Hz Rejection			High-Speed		
	Typical	Maximum		Typical	Maximum	
	23 °C ± 5 °C	-20 °C to 70 °C	-40 °C to 70 °C	23 °C ± 5 °C	-20 °C to 70 °C	-40 °C to 70 °C
-100 °C	0.55	1.63	1.63	0.57	1.75	2.11
0 °C	0.39	1.10	1.12	0.41	1.18	1.54
100 °C	0.33	0.84	1.03	0.34	0.91	1.38
300 °C	0.29	0.89	1.05	0.31	0.95	1.37
500 °C	0.31	1.07	1.23	0.33	1.12	1.54
700 °C	0.35	1.32	1.48	0.37	1.38	1.79
900 °C	0.39	1.61	1.76	0.42	1.67	2.09

Table 5. TB-9212 with Screw Terminal Thermocouple Type T/E Measurement Accuracy (°C)

Temperature	High-Resolution/Best 50 Hz Rejection/Best 60 Hz Rejection			High-Speed		
	Typical	Maximum		Typical	Maximum	
	23 °C ± 5 °C	-20 °C to 70 °C	-40 °C to 70 °C	23 °C ± 5 °C	-20 °C to 70 °C	-40 °C to 70 °C
-100 °C	1.06	2.59	2.59	1.08	2.70	2.84
0 °C	0.77	1.81	1.81	0.78	1.89	2.09
100 °C	0.64	1.43	1.48	0.65	1.49	1.83
300 °C	0.57	1.38	1.47	0.58	1.43	1.78
500 °C	0.58	1.56	1.63	0.60	1.61	1.94
700 °C	0.62	1.82	1.88	0.64	1.88	2.20
900 °C	0.67	2.12	2.18	0.70	2.19	2.51

Table 6. TB-9212 with Mini TC Thermocouple Type T/E Measurement Accuracy (°C)

Temperature	High-Resolution/Best 50 Hz Rejection/Best 60 Hz Rejection			High-Speed		
	Typical	Maximum		Typical	Maximum	
	23 °C ± 5 °C	-20 °C to 70 °C	-40 °C to 70 °C	23 °C ± 5 °C	-20 °C to 70 °C	-40 °C to 70 °C
0 °C	1.17	3.64	3.64	1.25	4.05	4.08
100 °C	0.85	2.60	2.60	0.91	2.90	3.10
300 °C	0.71	2.31	2.31	0.76	2.56	2.71
500 °C	0.68	2.36	2.36	0.74	2.59	2.71
700 °C	0.67	2.44	2.44	0.73	2.66	2.77
900 °C	0.66	2.52	2.52	0.72	2.73	2.82
1100 °C	0.66	2.62	2.62	0.71	2.82	2.89
1400 °C	0.68	2.90	2.90	0.75	3.11	3.16

Table 7. TB-9212 with Screw Terminal Thermocouple Type R/S Measurement Accuracy (°C)

Temperature	High-Resolution/Best 50 Hz Rejection/Best 60 Hz Rejection			High-Speed		
	Typical	Maximum		Typical	Maximum	
	23 °C ± 5 °C	-20 °C to 70 °C	-40 °C to 70 °C	23 °C ± 5 °C	-20 °C to 70 °C	-40 °C to 70 °C
0 °C	1.58	4.41	4.41	1.66	4.82	4.82
100 °C	1.15	3.18	3.18	1.21	3.47	3.47
300 °C	0.95	2.77	2.77	1.00	3.02	3.02
500 °C	0.90	2.79	2.79	0.96	3.02	3.02
700 °C	0.88	2.85	2.85	0.93	3.07	3.07
900 °C	0.85	2.90	2.90	0.91	3.11	3.11
1100 °C	0.84	2.98	2.98	0.90	3.18	3.18
1400 °C	0.86	3.25	3.25	0.93	3.46	3.46

Table 8. TB-9212 with Mini TC Thermocouple Type R/S Measurement Accuracy (°C)

Temperature	High-Resolution/Best 50 Hz Rejection/Best 60 Hz Rejection			High-Speed		
	Typical	Maximum		Typical	Maximum	
	23 °C ± 5 °C	-20 °C to 70 °C	-40 °C to 70 °C	23 °C ± 5 °C	-20 °C to 70 °C	-40 °C to 70 °C
300 °C	1.55	5.27	5.27	1.70	5.93	5.93
500 °C	0.97	3.39	3.39	1.05	3.80	3.80
700 °C	0.77	2.74	2.74	0.84	3.05	3.05
900 °C	0.63	2.41	2.41	0.69	2.66	2.66
1100 °C	0.57	2.30	2.30	0.62	2.52	2.52
1400 °C	0.53	2.32	2.32	0.59	2.52	2.52

Table 9. TB-9212 with Screw Terminal Thermocouple Type B Measurement Accuracy (°C)

Temperature	High-Resolution/Best 50 Hz Rejection/Best 60 Hz Rejection			High-Speed		
	Typical	Maximum		Typical	Maximum	
	23 °C ± 5 °C	-20 °C to 70 °C	-40 °C to 70 °C	23 °C ± 5 °C	-20 °C to 70 °C	-40 °C to 70 °C
300 °C	1.57	5.38	5.38	1.72	6.04	6.04

Temperature	High-Resolution/Best 50 Hz Rejection/Best 60 Hz Rejection			High-Speed		
	Typical	Maximum		Typical	Maximum	
	23 °C ± 5 °C	-20 °C to 70 °C	-40 °C to 70 °C	23 °C ± 5 °C	-20 °C to 70 °C	-40 °C to 70 °C
500 °C	0.98	3.46	3.46	1.07	3.87	3.87
700 °C	0.77	2.79	2.79	0.84	3.10	3.10
900 °C	0.63	2.45	2.45	0.69	2.71	2.71
1100 °C	0.57	2.33	2.33	0.63	2.55	2.55
1400 °C	0.54	2.35	2.35	0.59	2.55	2.55

Table 10. TB-9212 with Mini TC Thermocouple Type B Measurement Accuracy (°C)

Figure 1. TB-9212 with Screw Terminal Thermocouple Error Typical (High-Resolution, Best 50/60 Hz Rejection), 23 °C ±5 °C

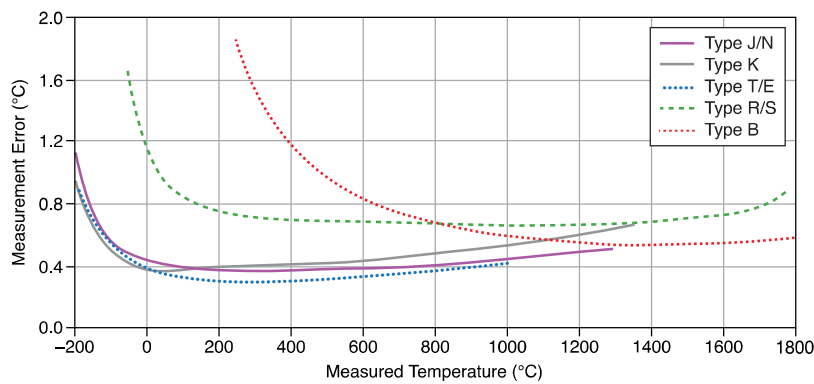

Figure 2. TB-9212 with Mini TC Thermocouple Error Typical (High-Resolution, Best 50/60 Hz Rejection), 23 °C ±5 °C

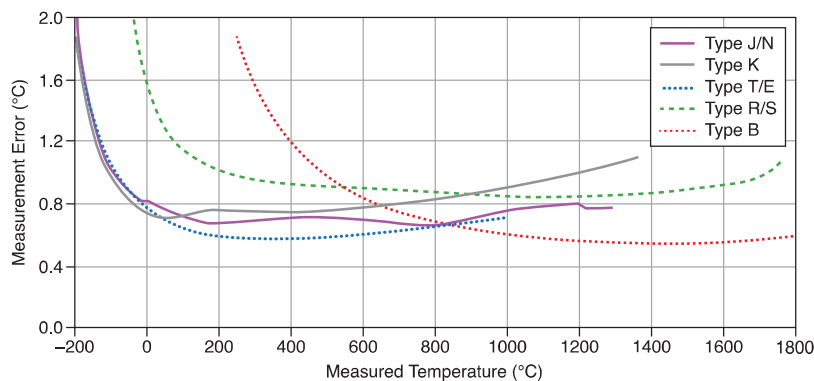

Figure 3. TB-9212 with Screw Terminal Thermocouple Error Typical (High-Speed), 23 °C ±5 °C

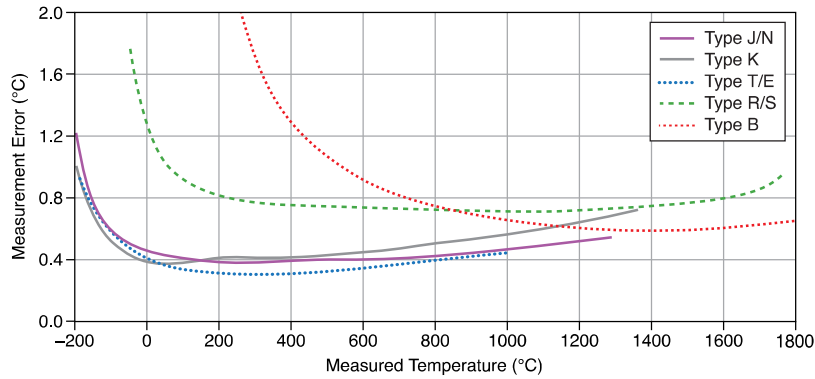

Figure 4. TB-9212 with Mini TC Thermocouple Error Typical (High-Speed), 23 °C ±5 °C

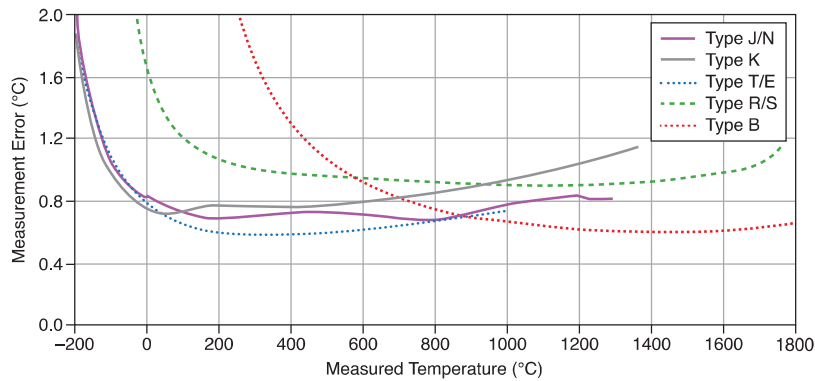

Figure 5. TB-9212 with Screw Terminal Thermocouple Error Maximum (High-Resolution, Best 50/60 Hz Rejection), -20 °C to 70 °C

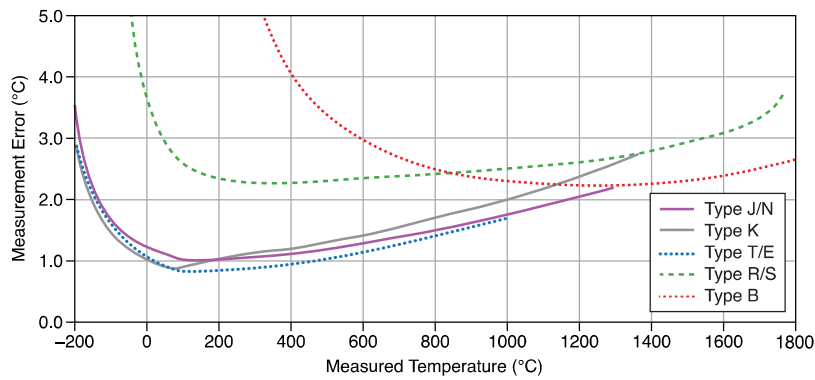

Figure 6. TB-9212 with Mini TC Thermocouple Error Maximum (High-Resolution, Best 50/60 Hz Rejection), -20 °C to 70 °C

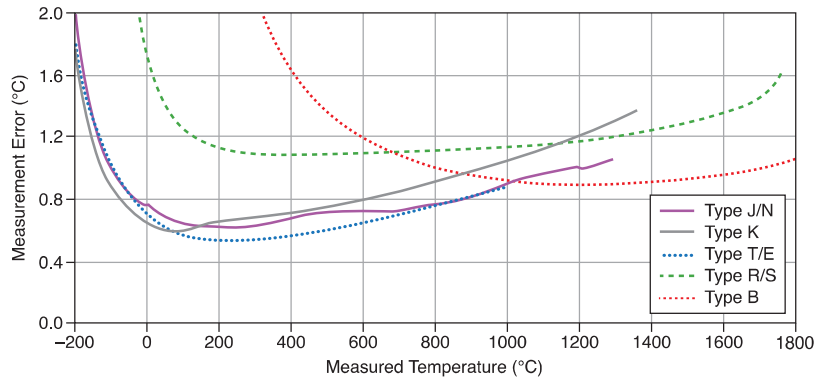

Figure 7. TB-9212 with Screw Terminal Thermocouple Error Maximum (High-Speed), -20 °C to 70 °C

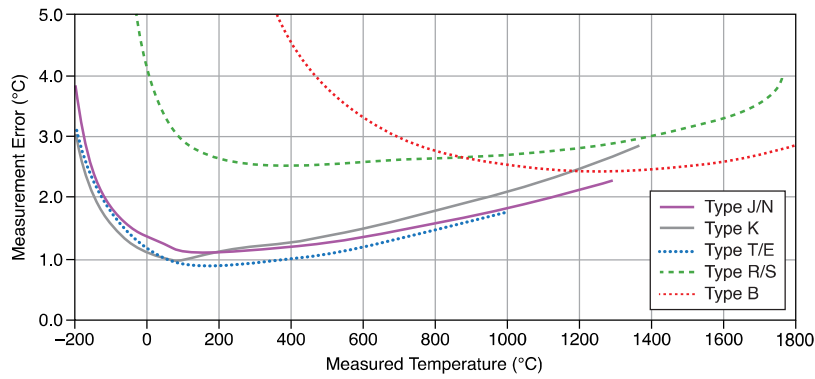
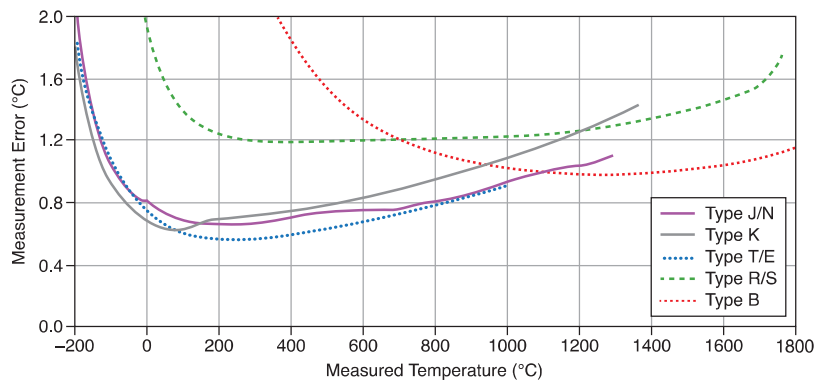

Figure 8. TB-9212 with Mini TC Thermocouple Error Maximum (High-Speed), -20 °C to 70 °C



Power Requirements

Power consumption from chassis

Active mode	670 mW maximum
Sleep mode	30 μ W maximum

Thermal dissipation (at 70 °C)

Active mode	1090 mW maximum
Sleep mode	480 mW maximum

Physical Characteristics

Screw-terminal wiring

Gauge 0.05 mm² to 0.5 mm² (30 AWG to 20 AWG) copper conductor wire

Wire strip length

Outer insulation 51 mm (2.0 in.) of insulation stripped from the end

Inner insulation 5.1 mm (0.2 in.) of insulation stripped from the end

Temperature rating 90 °C, minimum

Torque for screw terminals 0.3 N · m (2.66 lb · in.)

Wires per screw terminal One wire per screw terminal

TB-9212 securement

Securement type Jackscrews provided

Torque for jackscrews 0.4 N · m (3.6 lb · in.)

Weight

NI-9212	150 g (5.29 oz)
TB-9212 with screw terminal	92 g (3.25 oz)
TB-9212 with mini TC	120 g (4.23 oz)

Isolation Voltages

NI-9212 and TB-9212 with Screw Terminal Isolation Voltages

Connect only voltages that are within the following limits:

Channel-to-channel isolation**Up to 2,000 m altitude**

Continuous, for use in nonexplosive atmospheres 250 V RMS, Measurement Category II

Continuous, for use in explosive atmospheres 60 V DC, Measurement Category I

Withstand 1,500 V RMS, verified by a 5 s dielectric test

Up to 5,000 m altitude

Continuous 60 V DC, Measurement Category I

Withstand 1,000 V RMS, verified by a 5 s dielectric test

Channel-to-earth ground isolation**Up to 2,000 m altitude**

Continuous, for use in nonexplosive atmospheres	250 V RMS, Measurement Category II
Continuous, for use in explosive atmospheres	60 V DC, Measurement Category I
Withstand	3,000 V RMS, verified by a 5 s dielectric test

Up to 5,000 m altitude

Continuous	60 V DC, Measurement Category I
Withstand	1,000 V RMS, verified by a 5 s dielectric test

NI-9212 and TB-9212 with Mini TC Isolation Voltages

Connect only voltages that are within the following limits:

Channel-to-channel isolation, up to 5,000 m altitude

Continuous	60 V DC, Measurement Category I
Withstand	1,000 V RMS

Channel-to-earth ground isolation, up to 5,000 m altitude

Continuous	60 V DC, Measurement Category I
Withstand	1,000 V RMS

Hazardous Locations

U.S. (UL)	Class I, Division 2, Groups A, B, C, D, T4; Class I, Zone 2, AEx nA IIC T4 Gc
Canada (C-UL)	Class I, Division 2, Groups A, B, C, D, T4; Class I, Zone 2, Ex nA IIC T4 Gc
Europe (ATEX) and International (IECEX)	Ex nA IIC T4 Gc

Safety and Hazardous Locations Standards

This product is designed to meet the requirements of the following electrical equipment safety standards for measurement, control, and laboratory use:

- IEC 61010-1, EN 61010-1
- UL 61010-1, CSA 61010-1
- UL 61010-1, CSA 61010-1
- EN 60079-0:2012, EN 60079-15:2010
- IEC 60079-0: Ed 6, IEC 60079-15; Ed 4
- UL 60079-0; Ed 5, UL 60079-15; Ed 3
- CSA 60079-0:2011, CSA 60079-15:2012

Note For UL and other safety certifications, refer to the product label or the [Online Product Certification](#) section.

Electromagnetic Compatibility

- EN 61326-1 (IEC 61326-1): Class A emissions; Industrial immunity
- EN 55011 (CISPR 11): Group 1, Class A emissions
- AS/NZS CISPR 11: Group 1, Class A emissions

- FCC 47 CFR Part 15B: Class A emissions
- ICES-001: Class A emissions

CE Compliance

This product meets the essential requirements of applicable European Directives, as follows:

- 2014/35/EU; Low-Voltage Directive (safety)
- 2014/30/EU; Electromagnetic Compatibility Directive (EMC)
- 94/9/EC; Potentially Explosive Atmospheres (ATEX)

Product Certifications and Declarations

Refer to the product Declaration of Conformity (DoC) for additional regulatory compliance information. To obtain product certifications and the DoC for NI products, visit ni.com/product-certifications, search by model number, and click the appropriate link.

Shock and Vibration

To meet these specifications, you must panel mount the system.

Operating vibration	
Random (IEC 60068-2-64)	5 g _{rms} , 10 Hz to 500 Hz
Sinusoidal (IEC 60068-2-6)	5 g, 10 Hz to 500 Hz
Operating shock (IEC 60068-2-27)	30 g, 11 ms half sine; 50 g, 3 ms half sine; 18 shocks at 6 orientations

Environmental

Refer to the manual for the chassis you are using for more information about meeting these specifications.

Operating temperature (IEC 60068-2-1, IEC 60068-2-2)	-40 °C to 70 °C
Storage temperature (IEC 60068-2-1, IEC 60068-2-2)	-40 °C to 85 °C
Ingress protection	IP40
Operating humidity (IEC 60068-2-78)	10% RH to 90% RH, noncondensing
Storage humidity (IEC 60068-2-78)	5% RH to 95% RH, noncondensing
Pollution Degree	2
Maximum altitude	5,000 m

Indoor use only.

Environmental Management

NI is committed to designing and manufacturing products in an environmentally responsible manner. NI recognizes that eliminating certain hazardous substances from our products is beneficial to the environment and to NI customers.

For additional environmental information, refer to the **Engineering a Healthy Planet** web page at ni.com/environment. This page contains the environmental regulations and directives with which NI complies, as well as other environmental information not included in this document.

EU and UK Customers

-  **Waste Electrical and Electronic Equipment (WEEE)**—At the end of the product life cycle, all NI products must be disposed of according to local laws and regulations. For more information about how to recycle NI products in your region, visit ni.com/environment/weee.

电子信息产品污染控制管理办法（中国 RoHS）

-  **中国 RoHS**— NI 符合中国电子信息产品中限制使用某些有害物质指令(RoHS)。关于 NI 中国 RoHS 合规性信息，请登录 ni.com/environment/rohs_china。(For information about China RoHS compliance, go to ni.com/environment/rohs_china.)

Calibration

You can obtain the calibration certificate and information about calibration services for the NI-9212 at ni.com/calibration.

Calibration interval	1 year
----------------------	--------

¹ The warm-up time assumes the module is not in sleep mode, is facing forward or upward, and is in a constant ambient temperature. NI recommends allowing the full warm-up time.

² Measurement sensitivity is a function of noise and represents the smallest change in temperature that a sensor can detect. The values assume the maximum of the full measurement range of the standard thermocouple sensor according to NIST Monograph 175.