

HiPerFET™ Power MOSFETs Q-Class

IXFH/IXFT 30N50Q
IXFH/IXFT 32N50Q

V_{DSS}	I_{D25}	$R_{DS(on)}$
500 V	30 A	0.16 Ω
500 V	32 A	0.15 Ω

N-Channel Enhancement Mode
Avalanche Rated, Low Q_g , High dv/dt

$t_{rr} \leq 250$ ns

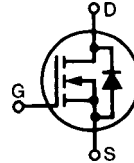

Symbol	Test Conditions	Maximum Ratings	
V_{DSS}	$T_J = 25^\circ\text{C}$ to 150°C	500	V
V_{DGR}	$T_J = 25^\circ\text{C}$ to 150°C ; $R_{GS} = 1$ M Ω	500	V
V_{GS}	Continuous	± 20	V
V_{GSM}	Transient	± 30	V
I_{D25}	$T_C = 25^\circ\text{C}$	30N50Q: 30 32N50Q: 32	A
I_{DM}	$T_C = 25^\circ\text{C}$, pulse width limited by T_{JM}	30N50Q: 120 32N50Q: 128	A
I_{AR}	$T_C = 25^\circ\text{C}$	32	A
E_{AR}	$T_C = 25^\circ\text{C}$	45	mJ
E_{AS}		1500	mJ
dv/dt	$I_S \leq I_{DM}$, $di/dt \leq 100$ A/ μs , $V_{DD} \leq V_{DSS}$, $T_J \leq 150^\circ\text{C}$, $R_G = 2$ Ω	5	V/ns
P_D	$T_C = 25^\circ\text{C}$	360	W
T_J		-55 ... +150	$^\circ\text{C}$
T_{JM}		150	$^\circ\text{C}$
T_{stg}		-55 ... +150	$^\circ\text{C}$
T_L	1.6 mm (0.063 in) from case for 10 s	300	$^\circ\text{C}$
M_d	Mounting torque	1.13/10	Nm/lb.in.
Weight	TO-247	6	g
	TO-268	4	g

TO-247 AD (IXFH)

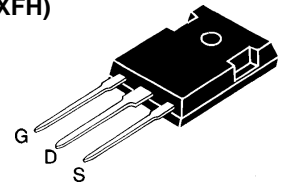

TO-268 (D3) (IXFT)

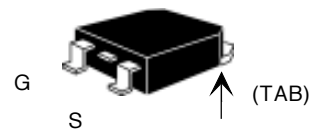

G = Gate D = Drain
S = Source TAB = Drain

Symbol	Test Conditions	Characteristic Values ($T_J = 25^\circ\text{C}$, unless otherwise specified)		
		min.	typ.	max.
V_{DSS}	$V_{GS} = 0$ V, $I_D = 250$ μA	500		V
$V_{GS(th)}$	$V_{DS} = V_{GS}$, $I_D = 4$ mA	2.5		4.5 V
I_{GSS}	$V_{GS} = \pm 20$ V _{DC} , $V_{DS} = 0$			± 100 nA
I_{DSS}	$V_{DS} = V_{DSS}$, $V_{GS} = 0$ V	$T_J = 25^\circ\text{C}$ $T_J = 125^\circ\text{C}$		100 μA 1 mA
$R_{DS(on)}$	$V_{GS} = 10$ V, $I_D = 0.5 I_{D25}$ Note 1	30N50Q 32N50Q		0.16 Ω 0.15 Ω

Features

- IXYS advanced low Q_g process
- Low gate charge and capacitances
 - easier to drive
 - faster switching
- International standard packages
- Low $R_{DS(on)}$
- Unclamped Inductive Switching (UIS) rated
- Molding epoxies meet UL 94 V-0 flammability classification

Advantages

- Easy to mount
- Space savings
- High power density

Symbol	Test Conditions	Characteristic Values ($T_J = 25^\circ\text{C}$, unless otherwise specified)		
		min.	typ.	max.
g_{fs}	$V_{DS} = 10\text{ V}; I_D = 0.5 \cdot I_{D25}$, Note 1	18	28	S
C_{iss}	$V_{GS} = 0\text{ V}, V_{DS} = 25\text{ V}, f = 1\text{ MHz}$	3950	4925	pF
C_{oss}		640	800	pF
C_{rss}		210	260	pF
$t_{d(on)}$	$V_{GS} = 10\text{ V}, V_{DS} = 0.5 \cdot V_{DSS}, I_D = 0.5 \cdot I_{D25}$ $R_G = 2\ \Omega$ (External),	35	45	ns
t_r		42	50	ns
$t_{d(off)}$		75	95	ns
t_f		20	25	ns
$Q_{g(on)}$	$V_{GS} = 10\text{ V}, V_{DS} = 0.5 \cdot V_{DSS}, I_D = 0.5 \cdot I_{D25}$	153	190	nC
Q_{gs}		26	32	nC
Q_{gd}		85	105	nC
R_{thJC}	(TO-247)		0.35	K/W
R_{thCK}		0.25		K/W

Symbol	Test Conditions	Characteristic Values ($T_J = 25^\circ\text{C}$, unless otherwise specified)		
		min.	typ.	max.
I_s	$V_{GS} = 0\text{ V}$			32 A
I_{SM}	Repetitive; pulse width limited by T_{JM}			128 A
V_{SD}	$I_F = I_s, V_{GS} = 0\text{ V}$, Note 1			1.5 V
t_{rr}	$I_F = I_s, -di/dt = 100\text{ A}/\mu\text{s}, V_R = 100\text{ V}$	0.75	250	ns
Q_{RM}		7.5		μC
I_{RM}				A

Note 1: Pulse test, $t \leq 300\ \mu\text{s}$, duty cycle $d \leq 2\%$

TO-247 AD (IXFH) Outline

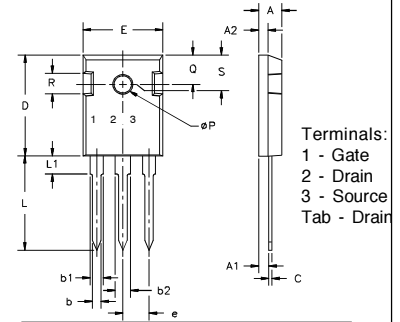

Dim.	Millimeter		Inches	
	Min.	Max.	Min.	Max.
A	4.7	5.3	.185	.209
A ₁	2.2	2.54	.087	.102
A ₂	2.2	2.6	.059	.098
b	1.0	1.4	.040	.055
b ₁	1.65	2.13	.065	.084
b ₂	2.87	3.12	.113	.123
C	.4	.8	.016	.031
D	20.80	21.46	.819	.845
E	15.75	16.26	.610	.640
e	5.20	5.72	0.205	0.225
L	19.81	20.32	.780	.800
L ₁		4.50		.177
∅P	3.55	3.65	.140	.144
Q	5.89	6.40	0.232	0.252
R	4.32	5.49	.170	.216
S	6.15	BSC	.242	BSC

Terminals:
1 - Gate
2 - Drain
3 - Source
Tab - Drain

TO-268 Outline

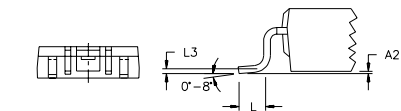
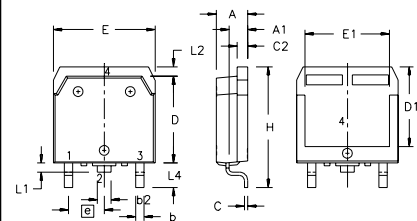

Terminals: 1 - Gate 2 - Drain
3 - Source Tab - Drain

SYM	INCHES		MILLIMETERS	
	MIN	MAX	MIN	MAX
A	.193	.201	4.90	5.10
A ₁	.106	.114	2.70	2.90
A ₂	.001	.010	0.02	0.25
b	.045	.057	1.15	1.45
b ₂	.075	.083	1.90	2.10
C	.016	.026	0.40	0.65
C ₂	.057	.063	1.45	1.60
D	.543	.551	13.80	14.00
D ₁	.488	.500	12.40	12.70
E	.624	.632	15.85	16.05
E ₁	.524	.535	13.30	13.60
e	.215	BSC	5.45	BSC
H	.736	.752	18.70	19.10
L	.094	.106	2.40	2.70
L ₁	.047	.055	1.20	1.40
L ₂	.039	.045	1.00	1.15
L ₃	.010	BSC	0.25	BSC
L ₄	.150	.161	3.80	4.10

IXYS reserves the right to change limits, test conditions, and dimensions.

IXYS MOSFETS and IGBTs are covered by one or more of the following U.S. patents: 4,835,592 4,881,106 5,017,508 5,049,961 5,187,117 5,486,715
4,850,072 4,931,844 5,034,796 5,063,307 5,237,481 5,381,025

Figure 1. Output Characteristics at 25°C

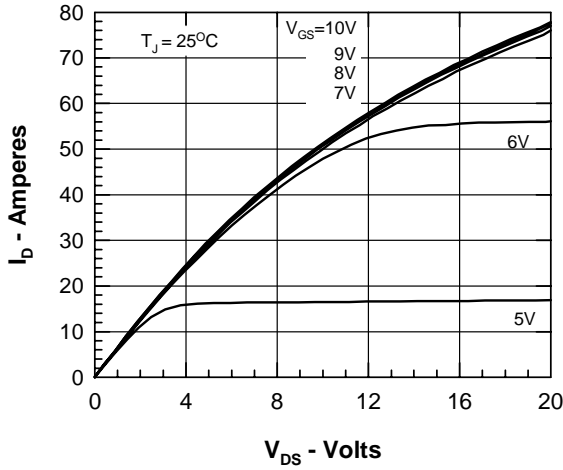

Figure 2. Output Characteristics at 125°C

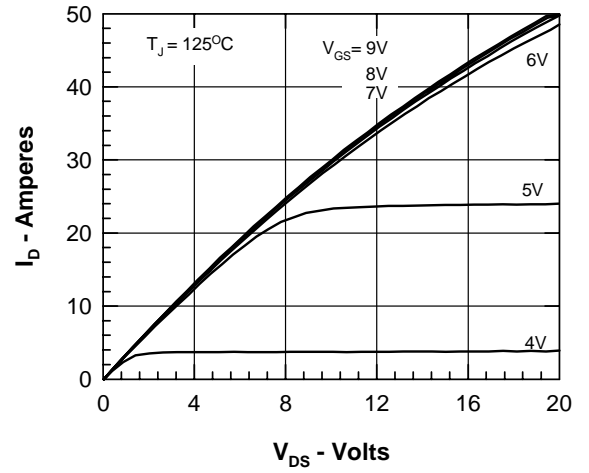

Figure 3. $R_{DS(on)}$ normalized to 15A/25°C vs. I_D

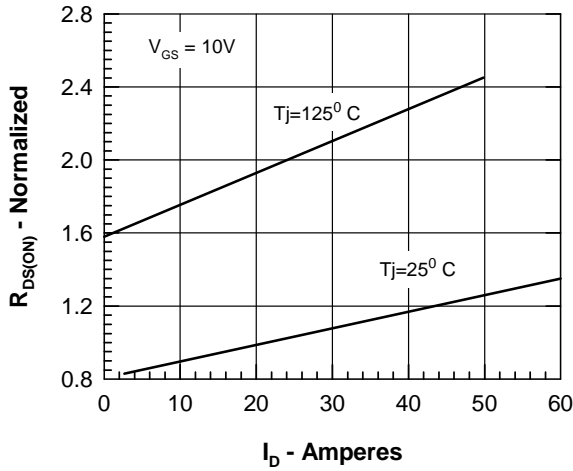

Figure 4. $R_{DS(on)}$ normalized to 15A/25°C vs. T_J

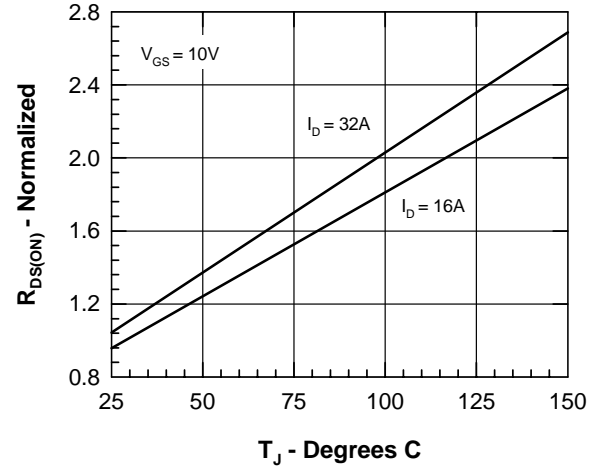

Figure 5. Drain Current vs. Case Temperature

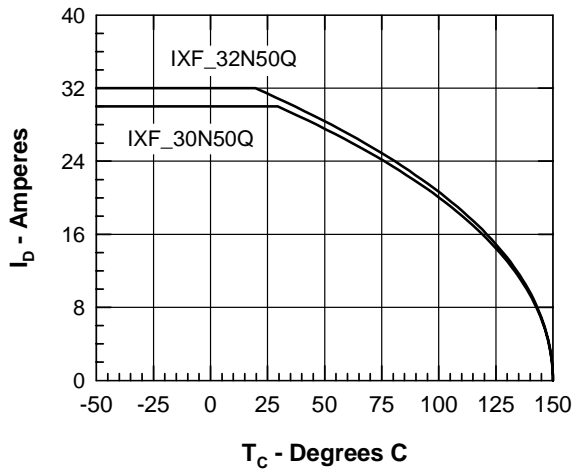

Figure 6. Admittance Curves

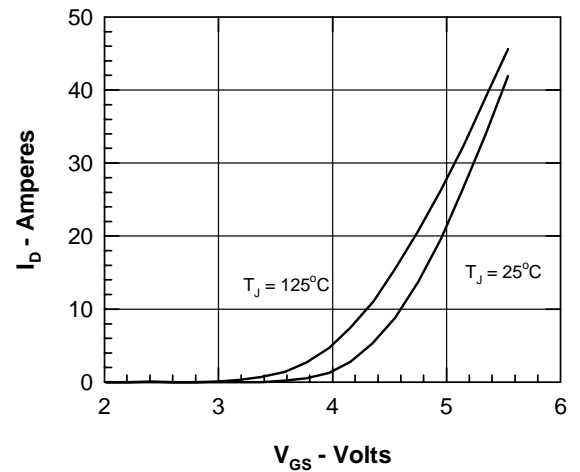

Figure 7. Gate Charge

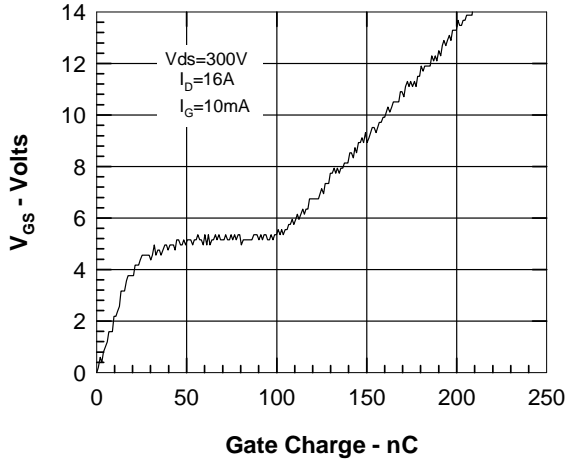

Figure 8. Capacitance Curves

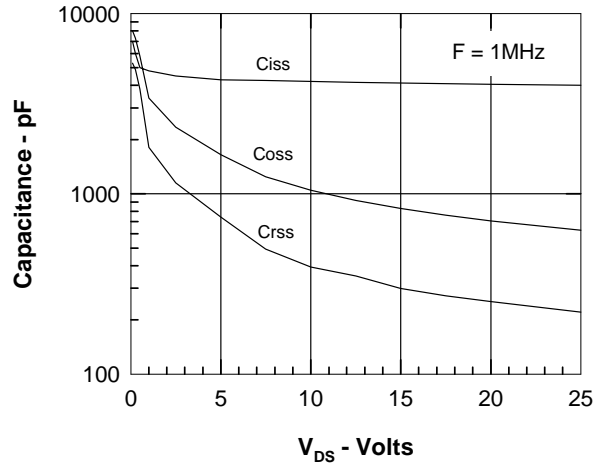

Figure 9. Forward Voltage Drop of the Intrinsic Diode

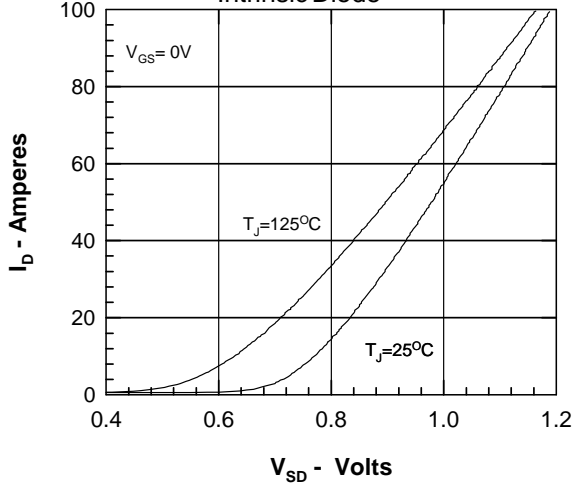
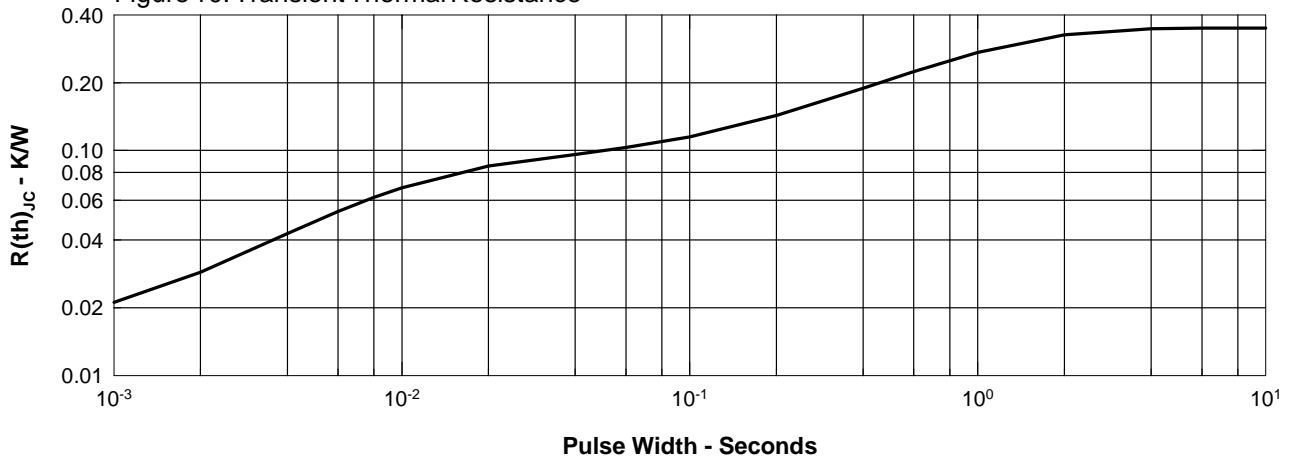

Figure 10. Transient Thermal Resistance



IXYS reserves the right to change limits, test conditions, and dimensions.

IXYS MOSFETS and IGBTs are covered by one or more of the following U.S. patents: 4,835,592 4,881,106 5,017,508 5,049,961 5,187,117 5,486,715
4,850,072 4,931,844 5,034,796 5,063,307 5,237,481 5,381,025