

Product Overview

The RFSW1012 is a single-pole double-throw (SPDT) switch designed for applications requiring very low insertion loss and high power handling capability. The excellent linearity performance of the RFSW1012 makes it ideal for use in LTE, WCDMA, and CDMA applications. This switch is ideally suited for use in CATV and SATV applications.

The RFSW1012 is packaged in a compact 2mm X 2mm, 12-pin, QFN package.

Functional Block Diagram

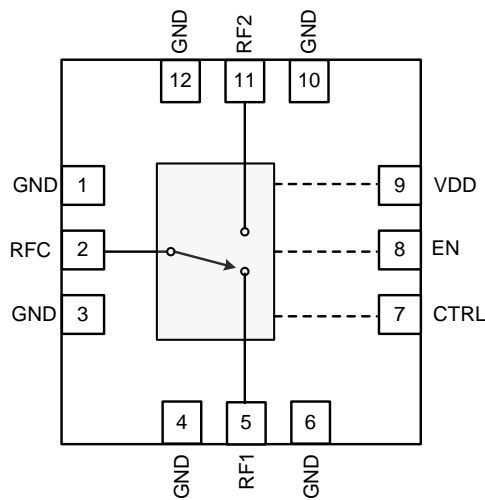

Top View

Key Features

- 5MHz to 6000MHz Operation
- 50Ω or 75Ω Applications
- Low Insertion Loss: 0.30dB at 1980MHz
- High Isolation: 37dB at 2GHz
- High IP3: >75dBm at 2GHz
- Compatible with Low Voltage Logic (V_{HIGH} Minimum = 1.3V)
- No External DC Blocking Capacitors Required on RF Paths Unless DC is Applied Externally
- 2000V HBM ESD Rating on All Ports
- CTB/CSO: >100dBc (41dBmV/ch., 137 Channels)

Applications

- LTE, WCDMA, GSM
- CATV, SATV Applications
- Post PA Switching
- General Purpose Switching Applications

Ordering Information

Part No.	Description
RFSW1012SR	7" Sample reel with 100 pieces
RFSW1012TR13	13" Reel with 2500 pieces
RFSW1012PCK-411	50Ω PCBA with 5-piece sample bag
RFSW1012PCK-410	75Ω PCBA with 5-piece sample bag

Absolute Maximum Ratings

Parameter	Rating
Storage Temperature	-50 to 150 °C
V _{DD}	+6 V
V _{EN} , V _{CTRL}	+3 V
Hot-Switching Max Pin (50 Ω load)	20 dBm
Pin max (CW)	+31dBm(5-25MHz) +34dBm (25-500MHz) +37dBm (>500MHz) +36dBm (>500MHz, 6:1VSWR)
Pin max (LTE, 9dB PAR, 1%, 105°C)	+32dBm (700-6000MHz, 2:1VSWR)

Operation of this device outside the parameter ranges given above may cause permanent damage.

Electrical Specifications – 50 Ω System

Test conditions, unless otherwise noted: Temp = 25°C, V_{DD} = +3 V. All RF ports terminated in 50Ω.

Parameter	Conditions	Min	Typ	Max	Units
Operational Frequency Range		5		6000	MHz
Insertion Loss	915MHz		0.25	0.45	dB
	1980MHz		0.30	0.51	dB
	2650MHz		0.40		dB
	5850MHz		0.45		dB
Isolation, RFC-RFX	915MHz	38	45		dB
	1980MHz	33	37		dB
	2650MHz	29	33		dB
	5850MHz		21		dB
Isolation (RF1-RF2)	915MHz	37	42		dB
	1980MHz	30	35		dB
	2650MHz	28	32		dB
	5850MHz		21		dB
Return Loss (On-State)			>15		dB
Input IP3	2.2GHz, 24dBm per tone, 1MHz tone spacing		75		dBm
Input IP2	Tone 1: 836.5MHz at +26dBm; Tone 2: 1718MHz at -20dBm, Rx freq: 881.5MHz		129		dBm
	Tone 1: 1880MHz at +26dBm; Tone 2: 3840MHz at -20dBm, Rx freq: 1960MHz		129		dBm
Max Operating Pin	5-25 MHz, 50Ω load			30	dBm
	25-500 MHz, 50Ω load			33	dBm
	>500 MHz, 50Ω load			36	dBm
P0.1dB	>100 MHz	41			dBm
Second Harmonic	900 MHz		-95	-75	dBc
	1800 MHz		-95	-75	dBc
Third Harmonic	900 MHz		-90	-75	dBc
	1800 MHz		-90	-75	dBc
Spurious Output	>5MHz, all ports terminated, no RF inputs		<-105		dBm
	<5MHz, all ports terminated, no RF inputs		<-100		dBm
Max Input Power	<400 MHz, 50 Ω load			34	dBm
	>400MHz, 50 Ω load			36	dBm
Device Voltage, V _{DD}		2.7	3	4.6	V
Leakage Current, I _{DD}	V _{EN} = High		100	200	μA
	V _{EN} = Low		14	20	μA
Control Voltage (V _{EN} , V _{CTRL})	Logic High	1.3	1.8	2.7	V
	Logic Low		0	0.45	V
Control Current	V _{CTRL} = High, V _{EN} = High		2.5	5	μA
	V _{CTRL} = Low, V _{EN} = High		1	3	μA
Switching Speed	50% Control to 10%/90% RF		2	5	μs

Recommended Operating Conditions

Parameter	Min	Typ	Max	Units
V _{DD}	+2.7	+5	+5.5	V
T _{CASE}	-40		+90	°C
T _j at MTTF>10 ⁶ hrs			125	°C

Electrical specifications are measured at specified test conditions. Specifications are not guaranteed over all recommended operating conditions.

Electrical Specifications – 75 Ω System

Test conditions, unless otherwise noted: Temp = 25°C, VDD = +3 V. All RF ports terminated in 50Ω.

Parameter	Conditions	Min	Typ	Max	Units
Operational Frequency Range		5		2500	MHz
Insertion Loss	5 MHz		0.15		dB
	200 MHz		0.2		dB
	915 MHz		0.3	0.45	dB
	1980 MHz		0.35	0.5	dB
	2200 MHz		0.45		dB
Isolation, RFC-RFX	5 MHz		70		dB
	200 MHz		50		dB
	915 MHz		36		dB
	1980 MHz		28		dB
	2200 MHz		26		dB
Isolation, RF1-RF2	5 MHz		>70		dB
	200 MHz		>70		dB
	915 MHz		48		dB
	1980 MHz		34		dB
	2200 MHz		32		dB
Return Loss (On-State)	Freq <1200 MHz		>15		dB
	1200 – 2500 MHz		>13		dB
CSO	41dBmV/ch, 137 channels)		>100		dBc
CTB	41dBmV/ch, 137 channels)		>100		dBc
XMOD	41dBmV/ch, 137 channels)		>90		dBc
Max Operating Input Power	5 – 25 MHz, 75 Ω load			30	dBm
	25 – 500 MHz, 75 Ω load			33	dBm
	>500 MHz, 75 Ω load			36	dBm

Logic Table

V _{CTRL}	V _{EN}	RFC-RF1	RFC-RF2
1	1	OFF	ON
0	1	ON	OFF
X	0	OFF	OFF

VDD = 2.7 – 4.6 V

Power Up/Down and Operational Controls

Scenario 1	Sequence for power up and power down from the phone battery or supply that is connected to RFSW1012 VBATT Pin.
Power Up	Turn on VBATT (supply), then EN, then CTRL. Then (20mS or greater), apply RF signal
Power Down	Turn off RF signal, then CTRL, then EN, turn off VBATT (supply)
Scenario 2	Sequence for going in and out of a shutdown mode, keeping the VBATT or supply on, but disabling / enabling the RFSW1012 by the EN pin
Power Up	Turn on EN (enable), then CTRL, then (5mS or greater), turn on RF Signal
Power Down	Turn off RF signal, then CTRL, then EN (disable)
Scenario 3	When changing switch positions between RF1 and RF2, no RF signal should be applied to any RF port while the CTRL is changing states
Switching Ports	Turn off RF signal, then change CTRL state, then wait (5mS or greater), then turn on RF signal

Application Circuit Schematic and Layout

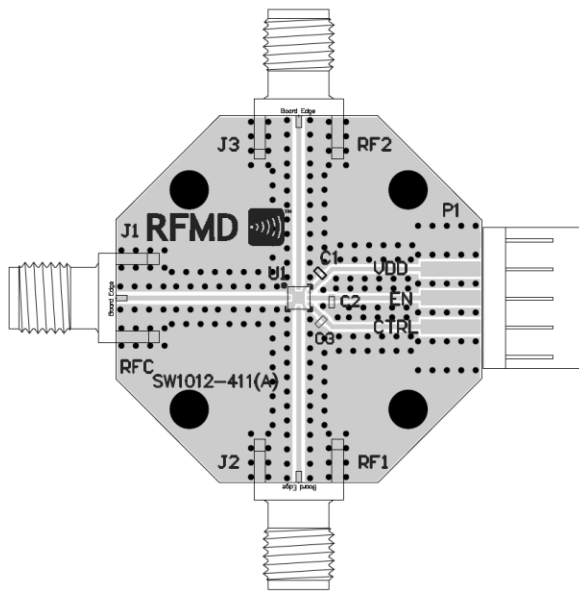
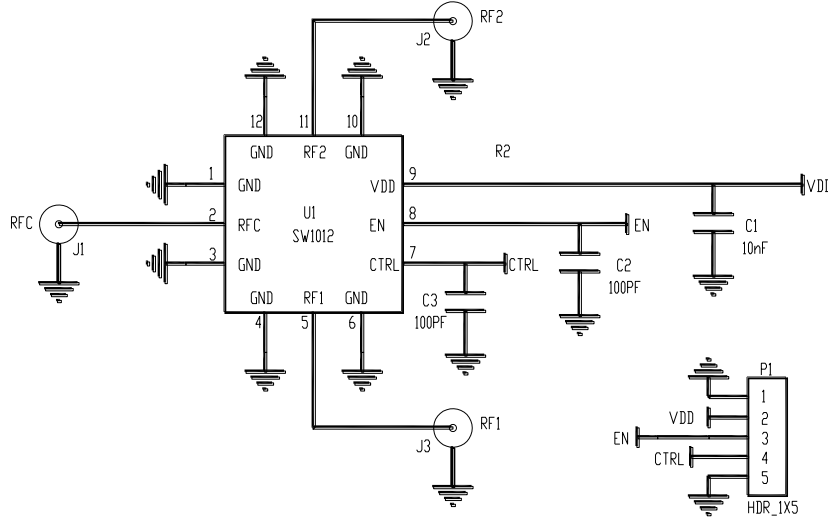

50Ω Evaluation Board

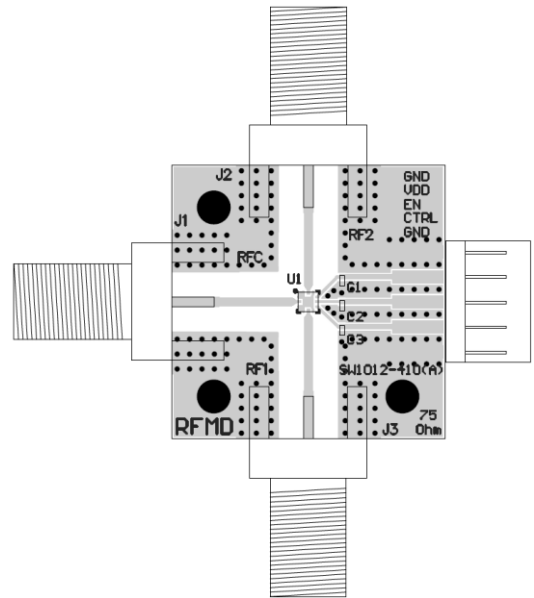

75Ω Evaluation Board

Bill of Material

Ref Des	Value	Description	Manuf.	Part Number
		50 Ω PCB, SW1012-411	Qorvo	
		75 Ω PCB, SW1012-410	Qorvo	
U1	na	High Isolation SPDT Switch, 2X2 QFN	Qorvo	RFSW1012
C1	10000 pF	CAP, 0402, 10%, 25V, X7R	Various	
C2, C3	100 pF	CAP, 0402, 5%, 50V, C0G	Various	

Performance Plots – 50 Ω

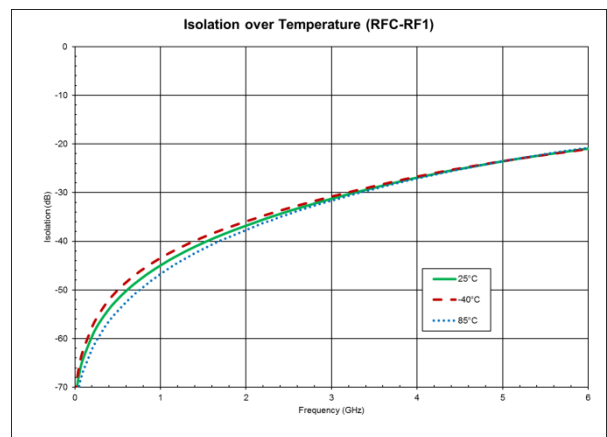
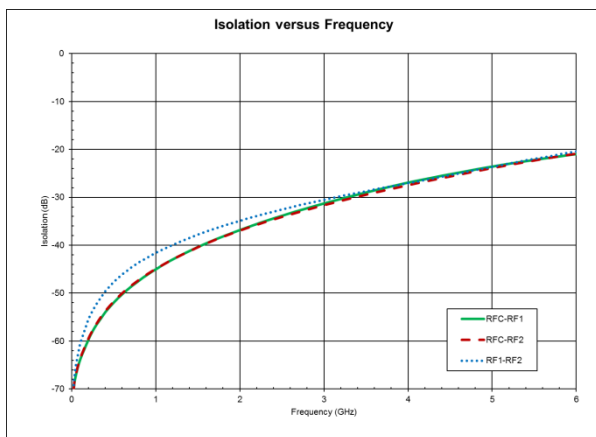
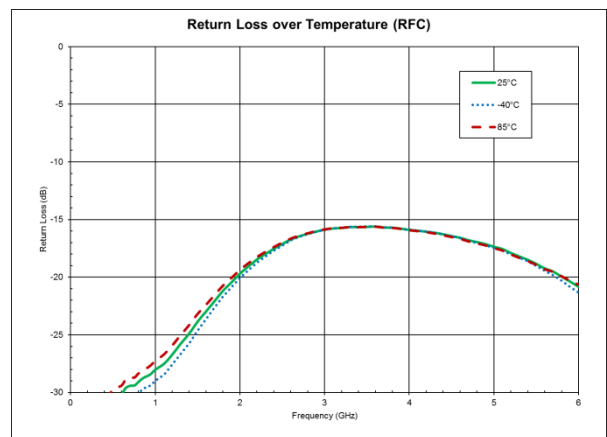
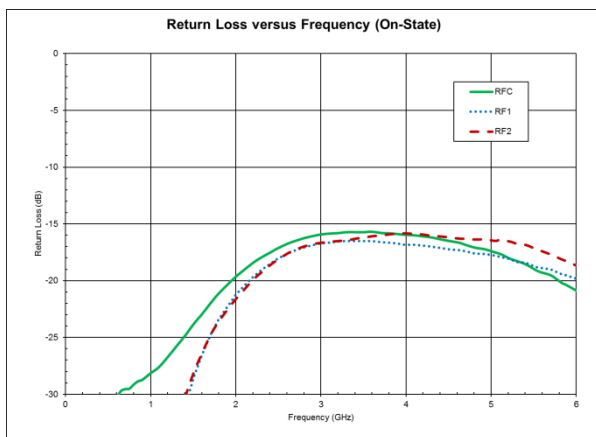
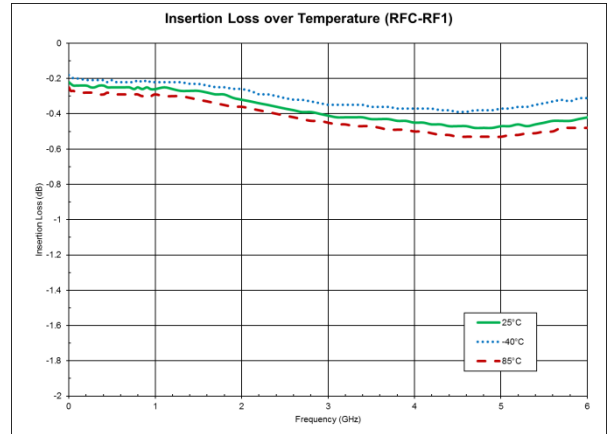
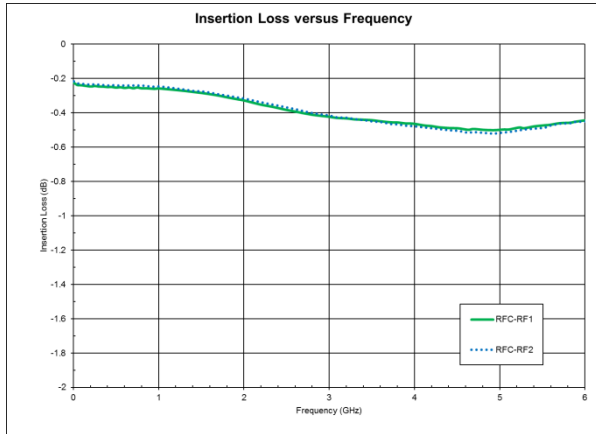

Performance Plots Contd. – 50 Ω

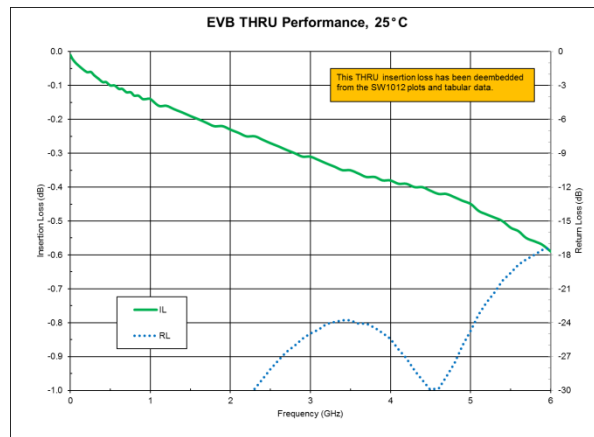
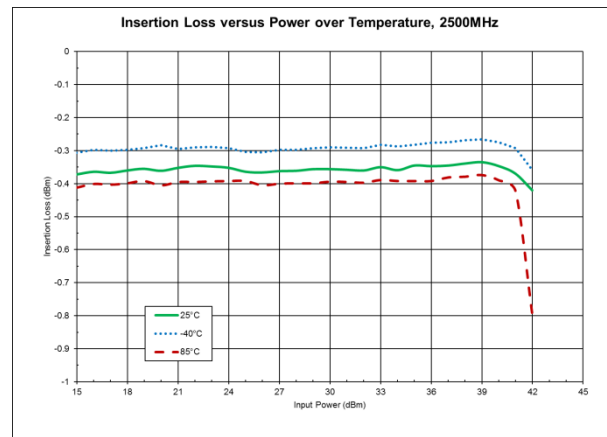
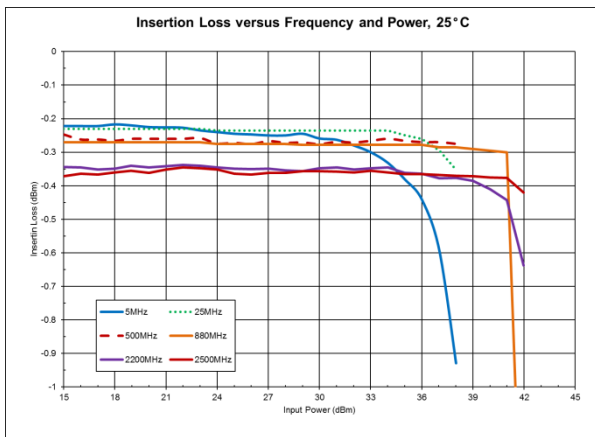
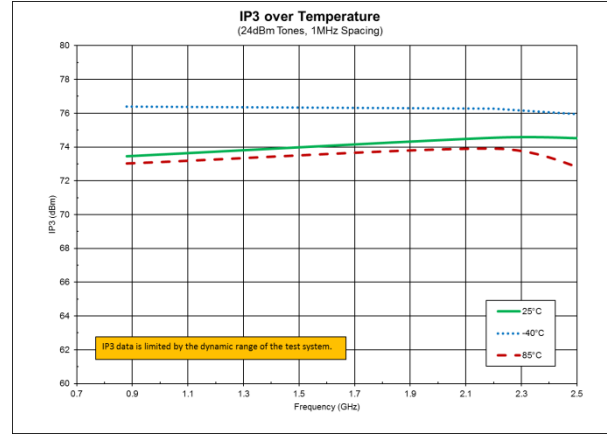
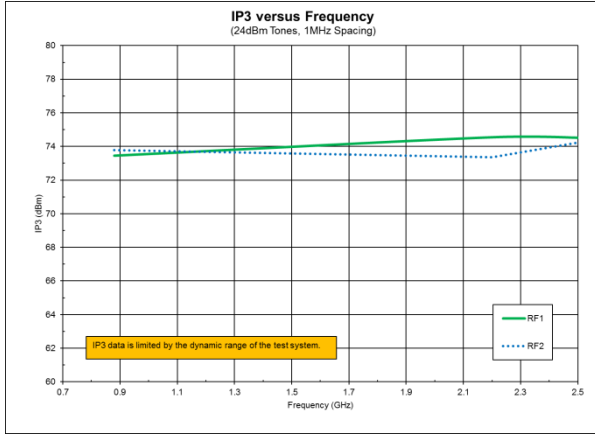

Performance Plots – 75 Ω

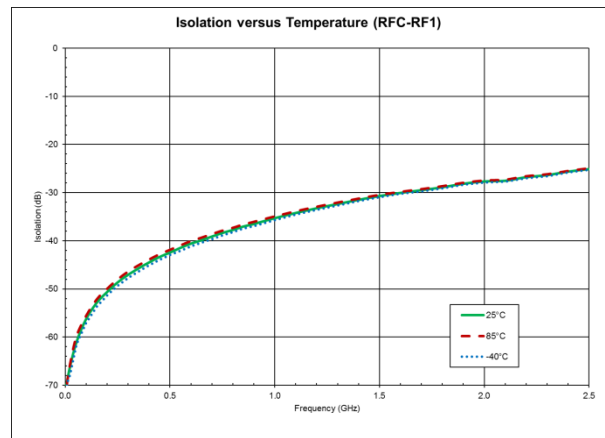
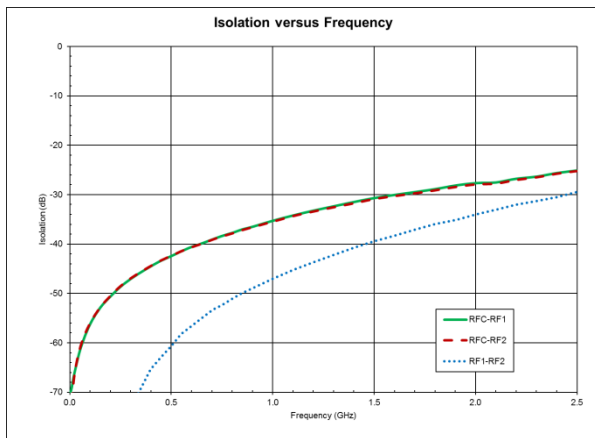
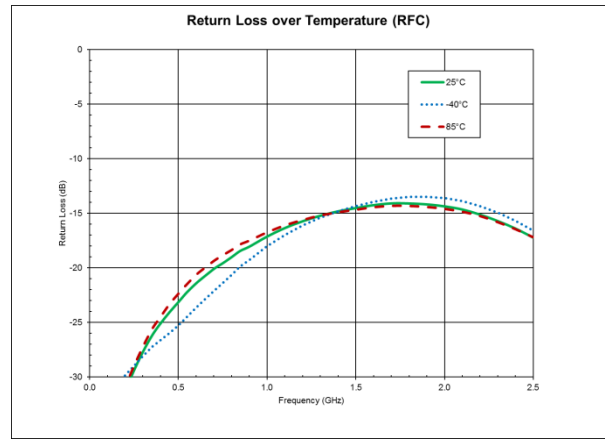
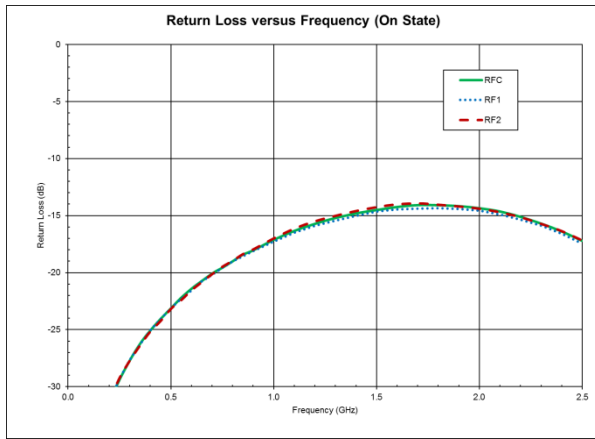
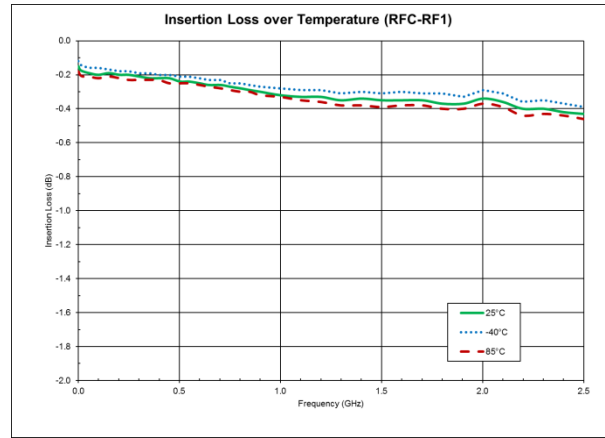
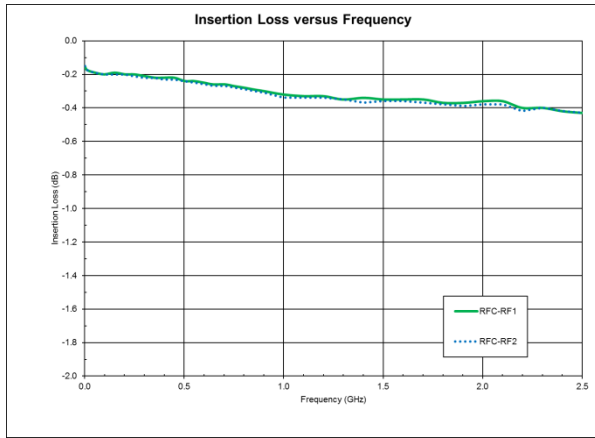

Performance Plots Contd. – 75 Ω

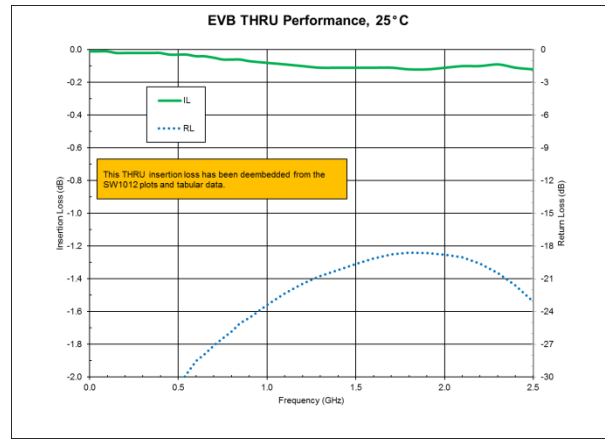
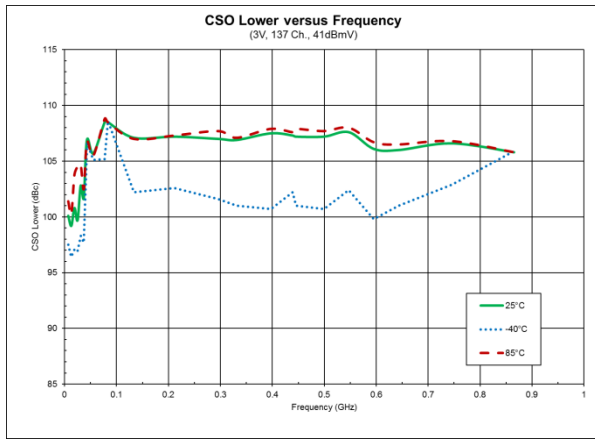
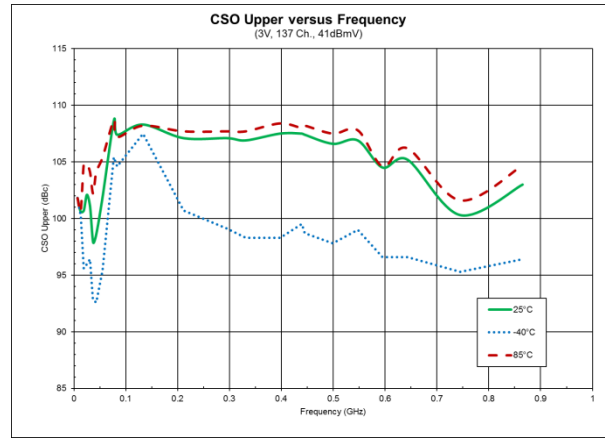
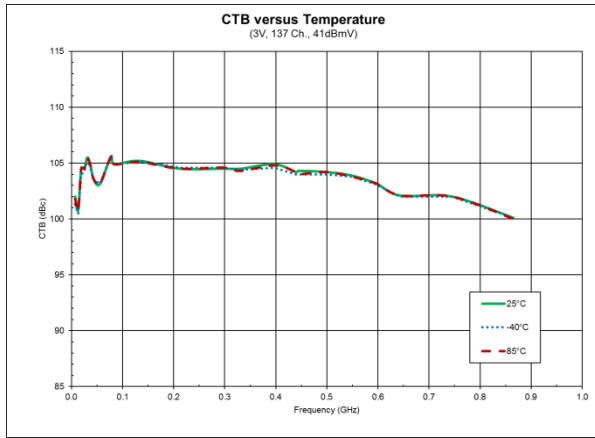

Pin Configuration and Description

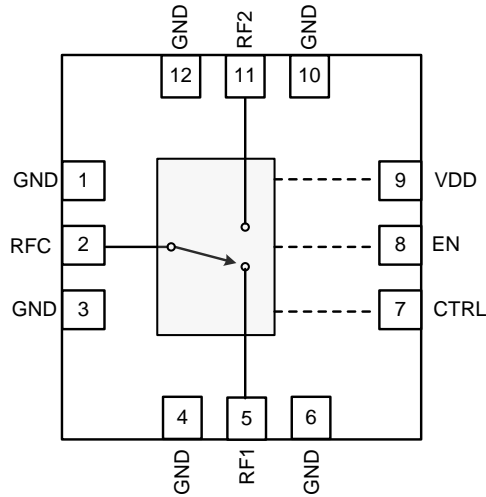

Top View

Pin No.	Label	Description
1, 3	GND	No internal connection but recommend to ground on board for proper mounting integrity.
4, 6, 10, 12	GND	Internally connected and must be grounded on board.
2	RFC	Single ended Common Port
5	RF1	Single Ended RF port
7	CTRL	Switch logic control input
8	EN	Shutdown logic control input
9	VDD	Supply Voltage
11	RF2	Single ended RF port
Backside Pad	GND	Ground connection. The back side of the package should be soldered to the ground plane. PCB vias under the device are required.

Package Marking and Dimensions

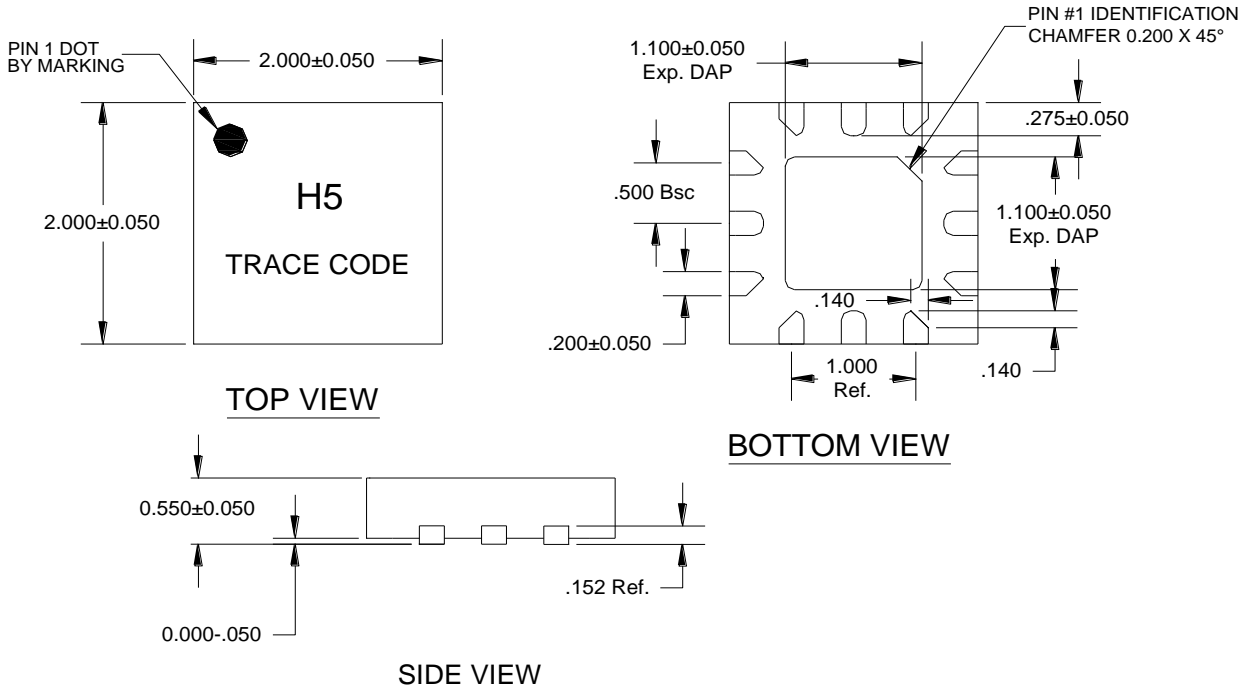

Trace Code to be assigned by assembly SubCon

Notes:

1. All dimensions are in mm. Angles are in degrees.
2. Dimension and tolerance formats conform to ASME Y14.4M-1994.
3. The terminal #1 identifier and terminal numbering conform to JESD 95-1 SPP-012.

Handling Precautions

Parameter	Rating	Standard
ESD – Human Body Model (HBM)	Class 2	ESDA / JEDEC JS-001-2012
ESD – Charged Device Model (CDM)	Class C3	JEDEC JESD22-C101F
MSL – Moisture Sensitivity Level	Level 2	IPC/JEDEC J-STD-020



Caution!
ESD-Sensitive Device

Solderability

Compatible with both lead-free (260°C max. reflow temp.) and tin/lead (245°C max. reflow temp.) soldering processes. Solder profiles available upon request.

Contact plating: Matte Tin

RoHS Compliance

This part is compliant with 2011/65/EU RoHS directive (Restrictions on the Use of Certain Hazardous Substances in Electrical and Electronic Equipment) as amended by Directive 2015/863/EU.

This product also has the following attributes:

- Lead Free
- Halogen Free (Chlorine, Bromine)
- Antimony Free
- TBBP-A (C₁₅H₁₂Br₄O₂) Free
- PFOS Free
- SVHC Free



Contact Information

For the latest specifications, additional product information, worldwide sales and distribution locations:

Tel: **1-844-890-8163**

Web: www.qorvo.com

Email: customer.support@qorvo.com

For technical questions and application information: Email: appsupport@qorvo.com

Important Notice

The information contained herein is believed to be reliable; however, Qorvo makes no warranties regarding the information contained herein and assumes no responsibility or liability whatsoever for the use of the information contained herein. All information contained herein is subject to change without notice. Customers should obtain and verify the latest relevant information before placing orders for Qorvo products. The information contained herein or any use of such information does not grant, explicitly or implicitly, to any party any patent rights, licenses, or any other intellectual property rights, whether with regard to such information itself or anything described by such information. **THIS INFORMATION DOES NOT CONSTITUTE A WARRANTY WITH RESPECT TO THE PRODUCTS DESCRIBED HEREIN, AND QORVO HEREBY DISCLAIMS ANY AND ALL WARRANTIES WITH RESPECT TO SUCH PRODUCTS WHETHER EXPRESS OR IMPLIED BY LAW, COURSE OF DEALING, COURSE OF PERFORMANCE, USAGE OF TRADE OR OTHERWISE, INCLUDING THE IMPLIED WARRANTIES OF MERCHANTABILITY AND FITNESS FOR A PARTICULAR PURPOSE.**

Without limiting the generality of the foregoing, Qorvo products are not warranted or authorized for use as critical components in medical, life-saving, or life-sustaining applications, or other applications where a failure would reasonably be expected to cause severe personal injury or death.

Copyright 2018 © Qorvo, Inc. | Qorvo is a registered trademark of Qorvo, Inc.