

STANDARD PARTS CATALOG AND

Engineering Design Guide

Electronics Website: www.earshockandvibe.com

Company Website: www.earsc.com



E·A·R™

Aero Technologies • a 3M company

Toll-Free Solutions Hotline
(877) EAR-IDEA
(327-4332)

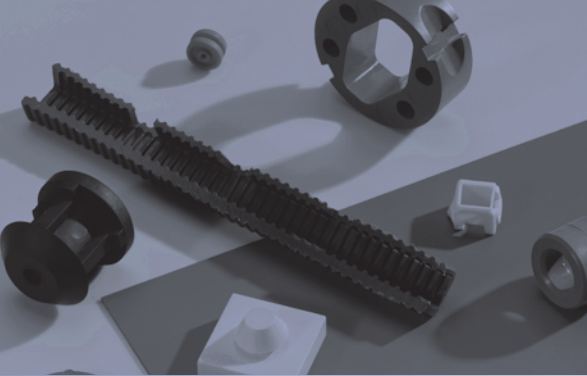

SOLUTION ENGINEERING FOR NOISE,

BROADEST LINES OF MATERIALS AND PARTS

ISODAMP® C-1000 SERIES ELASTOMERS

- Optimized shock and vibration control via high internal damping
- Control shock pulses in minimal sway space
- Three temperature-tuned formulations

TYPICAL APPLICATIONS:

- Hard disk drive mounting in computers, DVRs and MP3 players
- Fan and blower mounting (tool-less) for noise control
- Low rebound bumpers, crash stops and shock pads
- Stepper motor mounting

ISODAMP® C-8002 SERIES ELASTOMERS

- Environmentally-friendly, halogen-free formulation
- Optimized shock and vibration control via high internal damping
- Control shock pulses in minimal sway space

TYPICAL APPLICATIONS:

- Hard disk drive mounting in computers, DVRs and MP3 players
- Fan and blower mounting (tool-less) for noise control
- Low rebound bumpers, crash stops and shock pads
- Stepper motor mounting

VERSADAMP™ 2000 SERIES ELASTOMERS

- Provide uniform performance over a broad temperature range (-40C to 125C)
- Adjustable damping level from moderate to high
- Adjustable durometer (40 to 74 Shore A)
- Adjustable properties enable custom-tuned dynamic response
- 10 standard formulations

TYPICAL APPLICATIONS:

- Circuit board snubbers for portable electronics
- Hard disk drive protection in portable electronics
- LCD shock protection frames and bezels
- External bumpers for ruggedized portable electronics
- Microphone, speaker and other transducer isolation boots
- Isolation of vibration sources in automotive applications

ISOLOSS® HD THERMOSET ELASTOMER

- High internal damping
- Excellent resistance to creep and compression set
- Can be metal-bonded during molding

TYPICAL APPLICATIONS:

- Rotational vibration control for hard disk drives in servers and mass storage units (hot swap and fixed carrier designs)
- Isolation mounts for hard disk drive manufacturing test racks
- Standard and custom sandwich mounts

E-A-R Specialty Composites provides a wide range of materials and component options for controlling complex noise, vibration, motion and mechanical shock. Standard components include grommets, fan mounts, bushings and equipment feet. This extensive offering of standard parts will often provide an “off-the-shelf” solution that meets design requirements.

In addition, E-A-R offers the industry’s broadest range of engineered elastomer platforms specifically developed to address mechanical energy control challenges that are common in today’s complex OEM product designs.

Designers can choose from four standard materials platforms—**ISODAMP C-1000 Series** elastomers, **ISODAMP C-8002 Series** elastomers, **VersaDamp 2000 Series TPEs** and **ISOLOSS HD** thermoset polyurethanes—to obtain precisely the right combination of performance and physical properties.

The ISODAMP, ISOLOSS and VersaDamp material platforms are highly damped elastomers, exhibiting extremely low rebound characteristics. This ensures extremely low amplification at resonance and rapid settling to equilibrium after impulsive shock or vibration input.

In addition, the VersaDamp platform offers adjustable damping and stiffness, enabling the design engineer to custom-tune a part’s dynamic response. VersaDamp TPEs also offer an extended service temperature range, making them ideal for portable electronics and automotive applications.

E-A-R’s ISODAMP C-8002 Series thermoplastic molding material combines excellent damping performance and mechanical strength with compliance to environmental and other high cleanliness specifications, for high performance solutions in a wide variety of molded parts applications.

Additional features and typical applications for each of the materials platforms are listed at left. More detailed information on E-A-R’s full line of elastomers is contained in materials summary sheets and technical data sheets available directly from the company, on the Website at www.earsc.com or on the electronics Website at www.earshockandvibe.com.

Table of Contents

4	... ISODAMP & VersaDamp Grommets
7	... ISODAMP & VersaDamp Bushings
8	... ISODAMP Equipment Mounts
9	... ISODAMP Fan Mounts & Shoulder Bolts
10	... Performance Calculation Guide
13	... ISOLOSS Grommets & Mounts
15	... ISOLOSS Performance Calculation Guide
16	... Installation Hints
18	... Reduced Frequency Nomograms
19	... Typical Materials Properties
20	... Elastomer Comparison Guide

VIBRATION, SHOCK, CUSHIONING

THE DIFFERENCE IS THE DAMPING

E-A-R damped elastomers offer important advantages over poorly damped materials, such as natural and synthetic rubber, silicone and commodity TPEs. These advantages are especially important when attempting to control noise, shock and vibration in today's complex and component-dense OEM products.

Optimized Shock and Vibration Control

Vibration is typically characterized by continuous oscillatory motion of relatively small amplitude, while *shock* commonly features a relatively large, sudden change in acceleration due to an applied dynamic force. Consequently, vibration and shock considerations often place conflicting requirements on an isolation system.

A poorly damped isolator (typically made from natural rubber or silicone), that is soft enough for good vibration isolation, may require more sway space for deflection during a shock input than the product's design can provide. So a stiffer isolator may be needed to prevent crashing or bottoming out, but this could have a negative effect on vibration performance. E-A-R's highly damped elastomers help mitigate this common conflict.

Traditional practice has dictated that the natural frequency of an isolation mount be well below the operating frequency of the vibration source. This tactic seeks to avoid a situation where the source's operational frequency is near the mount's natural frequency, causing excessive amplification of the transmitted vibration. In practice, though, it is often difficult to avoid excitation of the isolation system's resonance, especially in complex systems that cycle on and off, change speed or produce broadband, multi-frequency vibration.

With E-A-R's highly damped elastomers, vibration amplification is minimized. Figure 1 illustrates how an elastomer's loss factor (η_m , a measure of hysteretic damping) influences vibration amplification. E-A-R's elastomers, with material loss factors near 1.0, exhibit a maximum amplification of only 3 to 5 dB (1.4X to 1.8X). Natural rubber or silicone isolators, with loss factors as low as 0.05, can exhibit excessive amplification as high as 25dB (18X). This reduced amplification minimizes the traditional need for an isolation system with a low natural frequency. As a result, a stiffer mount can be used to better accommodate shock requirements while still providing the vibration isolation performance necessary for most noise control applications.

Shock Protection: Reducing Space, Time and Magnitude

For most OEM shock protection applications, E-A-R's highly damped elastomers offer two important advantages:

- Lower peak acceleration (Gs) and displacement (sway) response to shock input, compared to poorly damped elastomers.
- Dramatically reduced settling time after shock input.

Figures 2 and 3 illustrate how the loss factor of an isolator material can influence shock response (transmitted acceleration and peak deflection). E-A-R's highly damped elastomers, with loss factors near 1.0, provide lower peak acceleration and deflection resulting in a higher degree of shock protection within a smaller package design. Poorly damped elastomers often require twice as much sway space to provide the same level of shock protection. This benefit is critical given the tight space constraints that are common in today's smaller portable electronic devices and component-dense OEM products.

In addition, as shown in Figures 2 and 3, E-A-R elastomers provide a quick return to equilibrium while the poorly damped system continues to oscillate and flex. Post-shock, resonant oscillation is a primary contributor to electromechanical system performance loss and component fatigue failure in portable electronic devices. E-A-R's highly damped elastomers help to reduce these post-shock oscillations, increase product performance and extend product life.

Figure 1

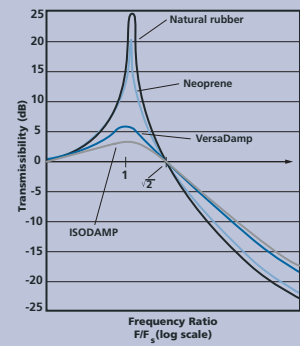

Poorly damped isolators can amplify incoming vibration, causing damage and excess noise. E-A-R isolators minimize this concern and better accommodate variable-frequency, impulsive or broadband vibration sources.

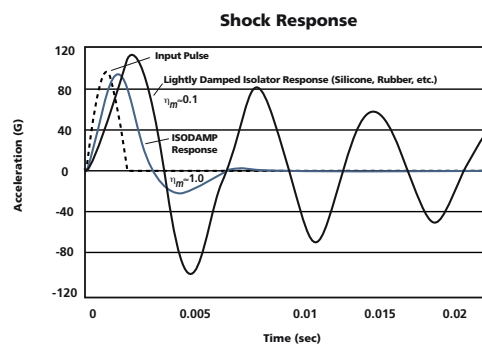

Figure 2

E-A-R elastomers result in lower peak Gs and faster settling, which can help to increase product performance.

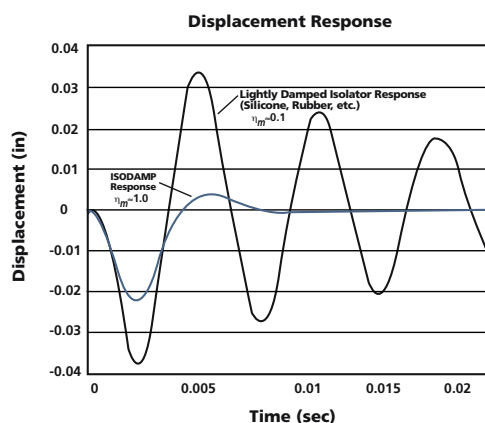
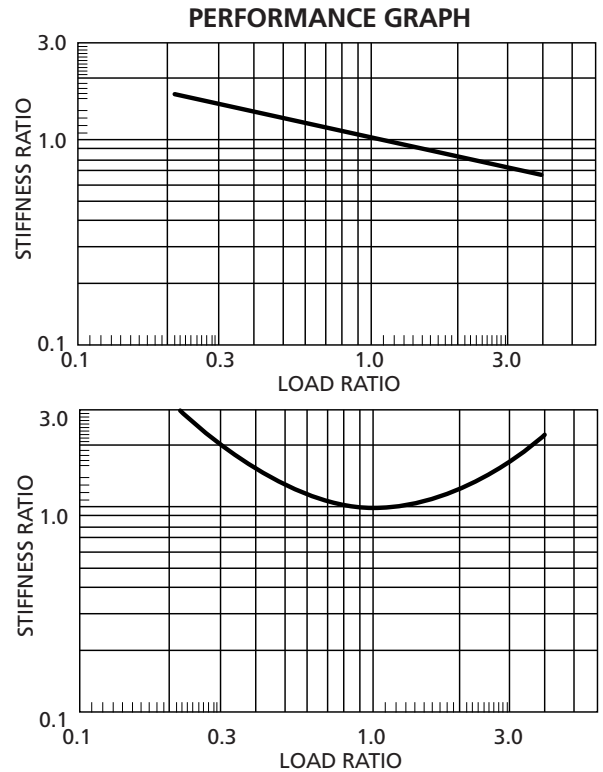
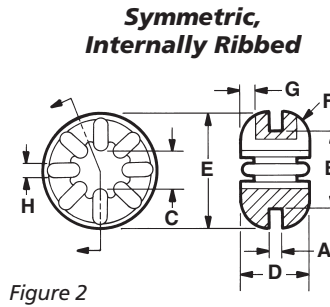
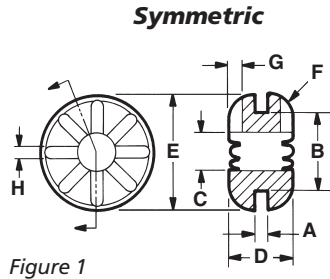

Figure 3

E-A-R elastomers reduce sway space requirements by nearly half, allowing for compact shock protection systems.

Ribbed



INSTALLATION HINTS
SEE PAGE 16

SYMMETRIC / SYMMETRIC INTERNALLY RIBBED

Figure No.	Part No.	Axial		Radial		Load (lb)	Dimensions (inches)							
		Load Factor (lb)	Stiffness Factor (lb/in)	Load Factor (lb)	Stiffness Factor (lb/in)		Recommended Maximum	A Plate Thckns.	B Hole Diam.	C Inside Diam.	D Overall Height	E Outside Diam.	F Edge Radius	G Rib Height
Figure 1	G-401	1.6	2091	0.9	6341	6.0	.063	.375	.224	.313	.563	.125	.063	.063
Figure 1	G-402	1.6	5130	1.8	9719	6.0	.125	.375	.226	.375	.563	.125	.063	.063
Figure 1	G-403	1.6	3361	0.9	7048	6.0	.063	.375	.276	.313	.625	.125	.063	.063
Figure 1	G-404	1.6	8200	1.8	9836	6.0	.125	.375	.281	.375	.625	.125	.063	.063
Figure 2	G-410	1.7	1988	0.5	2683	3.0	.057	.250	.158	.230	.379	.050	.040	.050
Figure 2	G-411	1.8	1911	0.9	1153	6.0	.063	.375	.188	.323	.563	.130	.063	.063
Figure 2	G-412	1.7	1988	0.5	2683	3.0	.031	.250	.158	.230	.379	.050	.040	.050
Figure 2	G-414	1.8	1911	0.9	1153	6.0	.043	.375	.188	.323	.563	.130	.063	.063

PERFORMANCE GRAPH

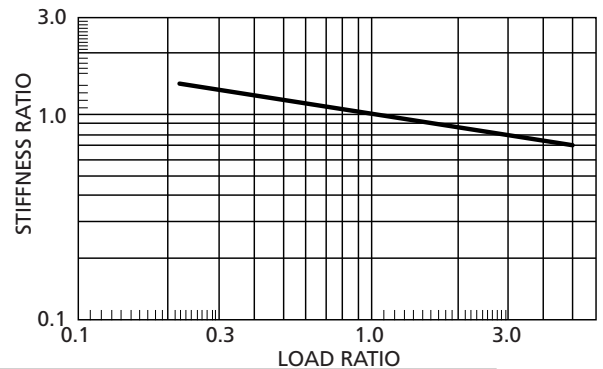

ASYMMETRIC

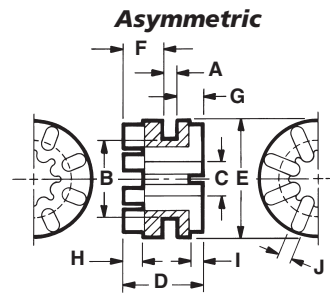

Part No.	Axial		Radial		Load (lb)	Dimensions (inches)							
	Load Factor (lb)	Stiffness Factor (lb/in)	Load Factor (lb)	Stiffness Factor (lb/in)		Recommended Maximum	A Plate Thckns.	B Hole Diam.	C Inside Diam.	D Overall Height	E Outside Diam.	F / G Lg./Sm. Flg. Height	H / I Lg./Sm. Rib Height
G-430	1.2	3724	0.8	2704	5.0	.055	.375	.180	.395	.560	.210/.130	.100/.065	.062
G-431	1.8	3789	1.2	2610	8.0	.055	.560	.172	.390	.750	.210/.125	.100/.065	.062

For C-1002 material, indicate "-1" after part number (e.g. G-401-1)
 For C-1105 material, indicate "-2" after the part number (e.g. G-401-2)
 For C-1100 material, indicate "-3" after the part number (e.g. G-401-3)
 For C-8002 material, indicate "-8" after the part number (e.g. G-401-8)
 For VersaDamp material, indicate "-formulation number" after the part number (e.g. G-401-2325)
 Dimensions given here are nominal. Exact specification print available on request.

	C-1002	C-1105	C-1100	C-8002	VersaDamp
Grommet Color	Blue	Turquoise	Yellow	Sky Blue	Black
Peak Performance Temp. Range at 1000 Hz	55F-105F (13C-41C)	80F-130F (27C-54C)	95F-145F (35C-63C)	62F-105F (17C-41C)	-40F-122F (-40C-50C)

*Refer to page 19 for additional temperature data.



Aearo Technologies - a 3M company

www.earshockandvibe.com www.earsc.com
E-mail: solutions@earsc.com

Toll-free hotline
(877) EAR-IDEA
(327-4332)

7911 Zionsville Road
650 Dawson Drive

Indianapolis, IN 46268
Newark, DE 19713

Phone (317) 692-1111
Phone (302) 738-6800

Fax (317) 692-3111
Fax (302) 738-6811

ISODAMP & VERSADAMP GROMMETS

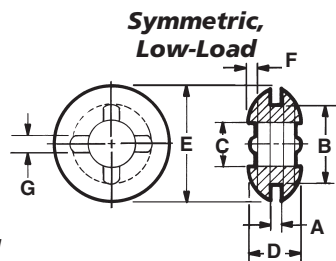

Figure 1

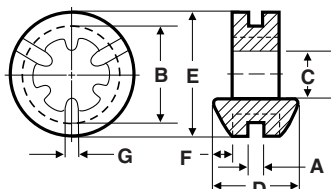

Figure 2

SYMMETRIC, LOW-LOAD

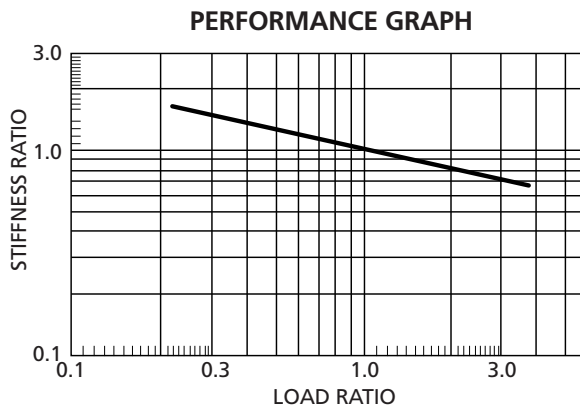
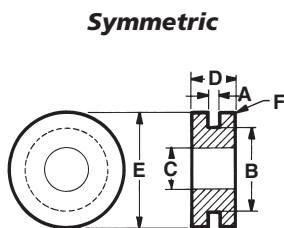

Figure No.	Part No.	Axial		Radial		Load (lb) Recommended Maximum	Dimensions (inches)						
		Load Factor (lb)	Stiffness Factor (lb/in)	Load Factor (lb)	Stiffness Factor (lb/in)		A Plate Thckns.	B Hole Diam.	C Inside Diam.	D Overall Height	E Outside Diam.	F Rib Height	G Rib Width
Figure 1	G-427	0.8	725	0.7	3475	1.5	.049	.312	.180	.194	.440	.025	.056
Figure 2	G-461	0.2	381	0.2	392	0.3	.037	.298	.157	.271	.393	.063	.051
Figure 2	G-462	0.2	381	0.2	392	0.3	.047	.304	.153	.276	.393	.063	.051

Non-Ribbed

INSTALLATION HINTS

SEE PAGE 16



Symmetric

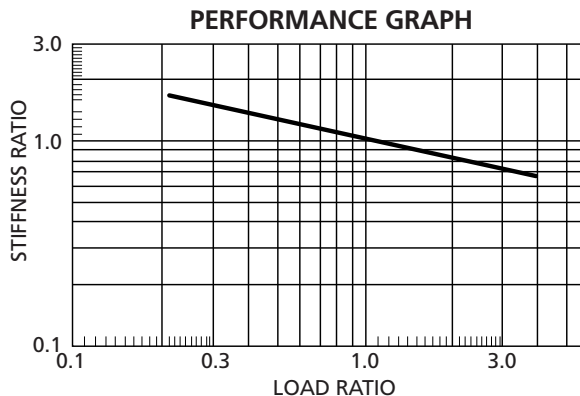

SYMMETRIC

Part No.	Axial		Radial		Load (lb) Recommended Maximum	Dimensions (inches)							
	Load Factor (lb)	Stiffness Factor (lb/in)	Load Factor (lb)	Stiffness Factor (lb/in)		A Plate Thckns.	B Hole Diam.	C Inside Diam.	D Overall Height	E Outside Diam.	F Edge Radius	G Lg. Flg. Height	H Sm. Flg. Height
G-501	4.2	17983	0.5	40450	17.0	.060	.360	.187	.120	.500	n/a	n/a	n/a
G-502	4.3	12985	0.8	10640	17.0	.063	.338	.182	.182	.500	n/a	n/a	n/a
G-503	2.1	6640	0.5	14495	10.0	.054	.244	.190	.306	.385	.020	n/a	n/a
G-504	3.0	12744	0.7	9170	13.0	.063	.309	.183	.187	.437	n/a	n/a	n/a
G-505	4.3	14745	0.8	15099	17.0	.062	.375	.190	.175	.500	n/a	n/a	n/a
G-506	3.3	12805	0.8	7252	14.0	.043	.319	.177	.220	.460	.020	n/a	n/a
G-507	9.0	7775	1.4	9739	40.0	.070	.503	.277	.396	.751	.050	n/a	n/a

For C-1002 material, indicate "-1" after part number (e.g. G-401-1)
 For C-1105 material, indicate "-2" after the part number (e.g. G-401-2)
 For C-1100 material, indicate "-3" after the part number (e.g. G-401-3)
 For C-8002 material, indicate "-8" after the part number (e.g. G-401-8)
 For VersaDamp material, indicate "-formulation number" after the part number (e.g. G-401-2325)

Dimensions given here are nominal. Exact specification print available on request.

	C-1002	C-1105	C-1100	C-8002	VersaDamp
Grommet Color	Blue	Turquoise	Yellow	Sky Blue	Black
Peak Performance Temp. Range at 1000 Hz	55F-105F (13C-41C)	80F-130F (27C-54C)	95F-145F (35C-63C)	62F-105F (17C-41C)	-40F-122F (-40C-50C)

*Refer to page 19 for additional temperature data.



Aearo Technologies - a 3M company

www.earshockandvibe.com www.earsc.com
 E-mail: solutions@earsc.com

Toll-free hotline
 (877) EAR-IDEA
 (327-4332)

7911 Zionville Road
 650 Dawson Drive

Indianapolis, IN 46268
 Newark, DE 19713

Phone (317) 692-1111
 Phone (302) 738-6800

Fax (317) 692-3111
 Fax (302) 738-6811

Non-ribbed

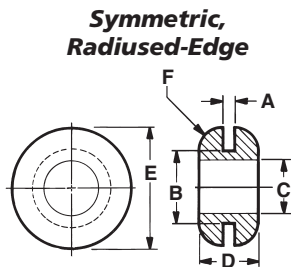

Figure 1

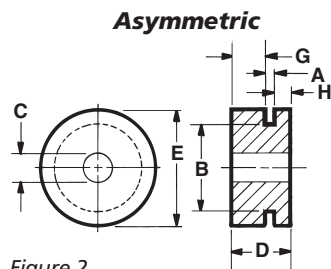
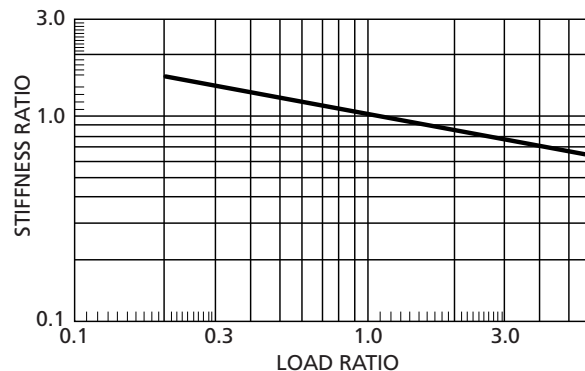
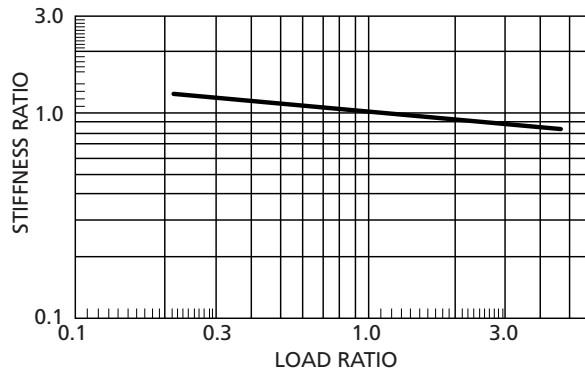

Figure 2

PERFORMANCE GRAPH



SYMMETRIC, RADIUS-EDGE / ASYMMETRIC

Figure No.	Part No.	Axial		Radial		Load (lb) Recommended Maximum	Dimensions (inches)							
		Load Factor (lb)	Stiffness Factor (lb/in)	Load Factor (lb)	Stiffness Factor (lb/in)		A Plate Thckns.	B Hole Diam.	C Inside Diam.	D Overall Height	E Outside Diam.	F Edge Radius	G Lg. Flg. Height	H Sm. Flg. Height
Figure 1	G-521	5.3	5593	0.9	7470	25.0	.062	.375	.270	.325	.625	.125	n/a	n/a
Figure 2	G-511	9.8	8467	1.4	5159	40.0	.063	.562	.180	.395	.753	n/a	.214	.118
Figure 2	G-512	6.5	5844	1.9	6951	26.0	.115	.437	.245	.620	.625	n/a	.380	.125
Figure 2	G-513	6.6	11465	1.4	12687	40.0	.078	.500	.304	.500	.750	n/a	.290	.132

INSTALLATION HINTS
SEE PAGE 16

Shear

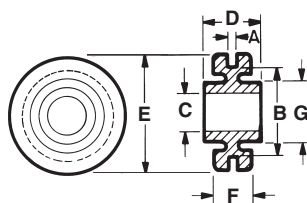

PERFORMANCE GRAPH

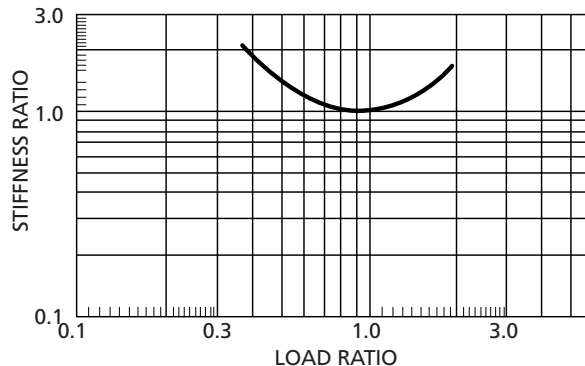

SHEAR

Part No.	Axial		Radial		Load (lb) Recommended Maximum	Dimensions (inches)						
	Load Factor (lb)	Stiffness Factor (lb/in)	Load Factor (lb)	Stiffness Factor (lb/in)		A Plate Thckns.	B Hole Diam.	C Inside Diam.	D Overall Height	E Outside Diam.	F Flange Thickns.	G Boss Out. Diam.
G-601	1.8	382	2.1	721	2.0	.056	.560	.248	.375	.750	n/a	n/a

For C-1002 material, indicate "-1" after part number (e.g. G-401-1)
 For C-1105 material, indicate "-2" after the part number (e.g. G-401-2)
 For C-1100 material, indicate "-3" after the part number (e.g. G-401-3)
 For C-8002 material, indicate "-8" after the part number (e.g. G-401-8)
 For VersaDamp material, indicate "-formulation number" after the part number (e.g. G-401-2325)
 Dimensions given here are nominal. Exact specification print available on request.

	C-1002	C-1105	C-1100	C-8002	VersaDamp
Grommet Color	Blue	Turquoise	Yellow	Sky Blue	Black
Peak Performance Temp. Range at 1000 Hz	55F-105F (13C-41C)	80F-130F (27C-54C)	95F-145F (35C-63C)	62F-105F (17C-41C)	-40F-122F (-40C-50C)

*Refer to page 19 for additional temperature data.



Aearo Technologies - a 3M company

www.earshockandvibe.com www.earsc.com
E-mail: solutions@earsc.com

Toll-free hotline (877) EAR-IDEA (327-4332)

7911 Zionsville Road
650 Dawson Drive

Indianapolis, IN 46268
Newark, DE 19713

Phone (317) 692-1111
Phone (302) 738-6800

Fax (317) 692-3111
Fax (302) 738-6811

Ribbed

Ribbed Bushings

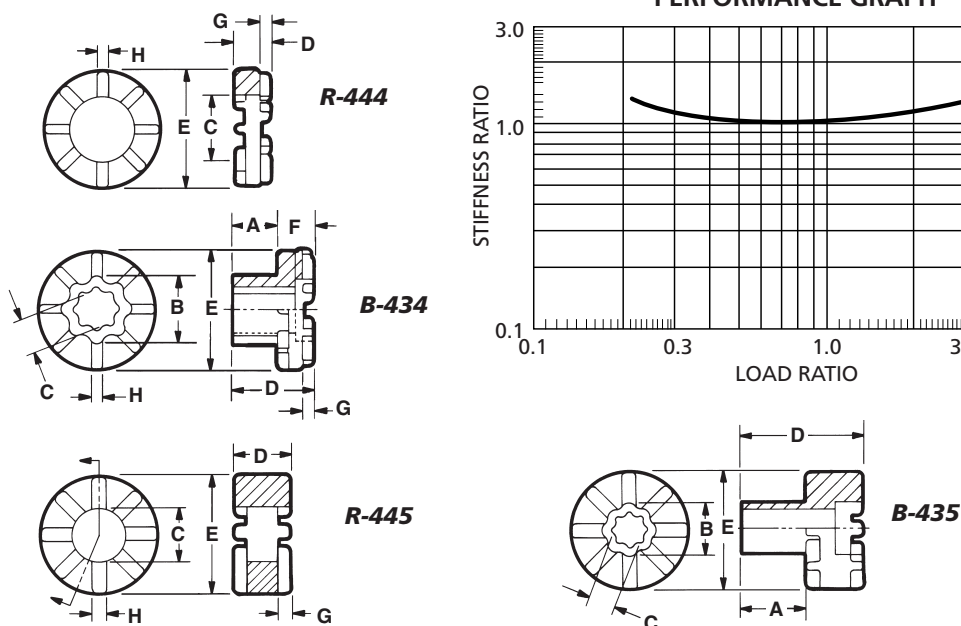

PERFORMANCE GRAPH

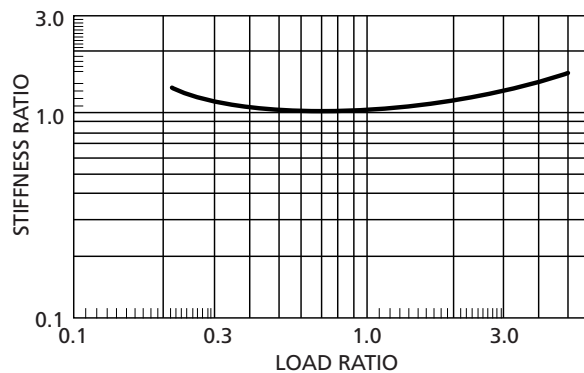

Part No.	Axial*		Radial*		Load (lb) Recommended Maximum	Dimensions (inches)							
	Load Factor (lb)	Stiffness Factor (lb/in)	Load Factor (lb)	Stiffness Factor (lb/in)		A Shank Height	B Shank Diam.	C Inside Diam.	D Overall Height	E Flange Diam.	F Flange Height	G Rib Height	H Rib Width
R-444	2.1	1192	1.5	1095	10.0	n/a	n/a	.460	.250	.813	n/a	.078	.085
B-434	2.1	1192	1.5	1095	10.0	.313	.469	.260	.563	.813	.250	.078	.085
R-445	6.3	650	2.5	1000	25.0	n/a	n/a	.457	.520	1.000	n/a	.132	.125
B-435	6.3	650	2.5	1000	25.0	.544	.473	.260	1.060	1.000	.516	.132	.135

* Normalized data using rings and bushings together

INSTALLATION HINTS

SEE PAGE 16

Non-ribbed

Non-ribbed Bushings

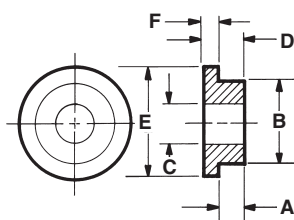

PERFORMANCE GRAPH

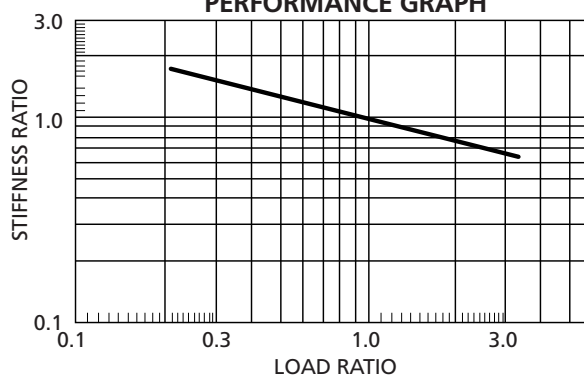

Part No.	Axial		Radial		Load (lb) Recommended Maximum	Dimensions (inches)							
	Load Factor (lb)	Stiffness Factor (lb/in)	Load Factor (lb)	Stiffness Factor (lb/in)		A Shank Height	B Shank Diam.	C Inside Diam.	D Overall Height	E Flange Diam.	F Flange Height	G Rib Height	H Rib Width
B-531	4.1	20235	3.5	15575	17.0	.120	.360	.189	.175	.500	.055	n/a	n/a
B-532	9.5	30725	4.2	20772	40.0	.139	.420	.271	.259	.750	.120	n/a	n/a
B-533	28.5	30500	5.0	11500	100.0	.085	.750	.427	.325	1.265	.240	n/a	n/a

For C-1002 material, indicate "-1" after part number (e.g. G-401-1)
 For C-1105 material, indicate "-2" after the part number (e.g. G-401-2)
 For C-1100 material, indicate "-3" after the part number (e.g. G-401-3)
 For C-8002 material, indicate "-8" after the part number (e.g. G-401-8)
 For VersaDamp material, indicate "-formulation number" after the part number (e.g. G-401-2325)
 Dimensions given here are nominal. Exact specification print available on request.

	C-1002	C-1105	C-1100	C-8002	VersaDamp
Grommet Color	Blue	Turquoise	Yellow	Sky Blue	Black
Peak Performance Temp.	55F-105F	80F-130F	95F-145F	62F-105F	-40F-122F
Range at 1000 Hz	(13C-41C)	(27C-54C)	(35C-63C)	(17C-41C)	(-40C-50C)

*Refer to page 19 for additional temperature data.



Aearo Technologies - a 3M company

www.earshockandvibe.com www.earsc.com
 E-mail: solutions@earsc.com

Toll-free hotline
 (877) EAR-IDEA
 (327-4332)

7911 Zionville Road
 650 Dawson Drive

Indianapolis, IN 46268
 Newark, DE 19713

Phone (317) 692-1111
 Phone (302) 738-6800

Fax (317) 692-3111
 Fax (302) 738-6811

ISODAMP EQUIPMENT MOUNTS

C-1002 MOUNTING PADS

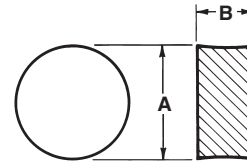

Part No.	Load (lb) Recommended Maximum	Dimensions (inches)					
		A Diam.	B Overall Height	C Inside Diam.	D Overall Height	E Outside Diam.	F Bolt Flg. Height
MP-506	15.0	.500	.060	n/a	n/a	n/a	n/a
MP-512	15.0	.500	.125	n/a	n/a	n/a	n/a
MP-725	30.0	.743	.260	n/a	n/a	n/a	n/a
MP-1025	30.0	0.98	.240	n/a	n/a	n/a	n/a

C-1002 MOUNTING FEET

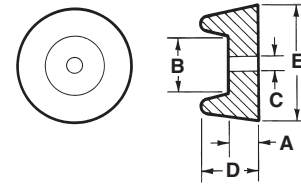

Part No.	Load (lb) Recommended Maximum	Dimensions (inches)					
		A Bolt Flg. Height	B Bolt Flg. Diam.	C Inside Diam.	D Overall Height	E Outside Diam.	F Bolt Flg. Height
MF-1010	15.0	.270	.493	.123	.521	.982	n/a
MF-1010PSA	15.0	.270	.493	.123	.521	.982	n/a

C-1002 MOUNTING FEET

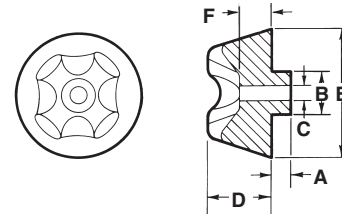

Part No.	Load (lb) Recommended Maximum	Dimensions (inches)					
		A Shank Height	B Shank Diam.	C Inside Diam.	D Mount Height	E Mount Diam.	F Bolt Flg. Height
L-020	20.0	.215	.500	.194	.755	1.502	.410
L-021	20.0	n/a	n/a	.194	.755	1.502	.410
L-030	20.0	.215	.509	.325	.755	1.502	.410
L-031	20.0	n/a	n/a	.320	.755	1.502	.410

C-1002 EQUIPMENT MOUNTS

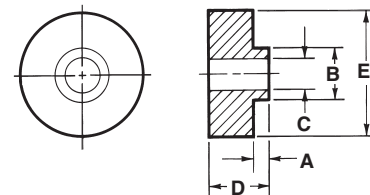

Part No.	Load (lb) Recommended Maximum	Dimensions (inches)					
		A Shank Diam.	B Shank Diam.	C Inside Diam.	D Mount Height	E Mount Diam.	F Bolt Flg. Height
ML-4250	70.0	.125	.500	.327	.625	1.172	n/a
ML-42100	140.0	.188	.750	.443	.820	1.656	n/a
ML-42200	300.0	.260	1.010	.575	1.007	2.371	n/a
ML-42500	700.0	.355	1.000	.549	1.385	3.667	n/a

Dimensions given here are nominal. Exact specification print available on request.



Aearo Technologies - a 3M company

www.earshockandvibe.com www.earsc.com
E-mail: solutions@earsc.com

Toll-free hotline
(877) EAR-IDEA
(327-4332)

7911 Zionsville Road Indianapolis, IN 46268
650 Dawson Drive Newark, DE 19713

Phone (317) 692-1111
Phone (302) 738-6800

Fax (317) 692-3111
Fax (302) 738-6811

ISODAMP FAN MOUNTS

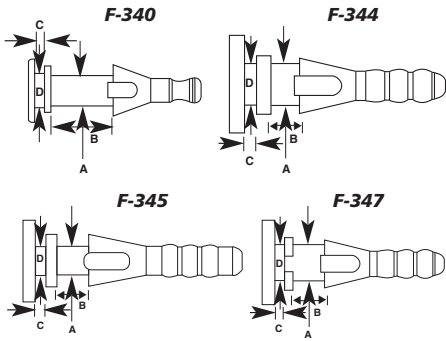

Part No.	Dimensions (mm)				Suggested Fan Sizes (mm)	
	A Fan Hole Diam	B Fan Hole Depth	C Plate Thickness	D Plate Hole Diam	Flange Thickness	Hole Diameter
F-340	2.5	5.0	.80	2.75	4.5-5.5	2.5-3.5
F-344	4.4	3.0	1.3	4.4	2.5-3.5	3.8-4.7
F-345	3.5	3.8	1.3	3.5	3.3-4.3	3.9-5.3
F-347	4.4	4.5	0.8	4.5	3.9-5.0	3.7-4.7

INSTALLATION HINTS

SEE PAGE 16 & 17

SHOULDER BOLTS

Material: low-carbon steel with zinc chromate coating

Part No.	Grommet	Dimensions (inches)			
		A Head ± .020	D Shoulder Length ± .005	F Shoulder ± .0025	G Thread
SB-4102	G-410	.350	.214	.161	6-32 UNC-2A
SB-4105	G-410	.350	.214	.161	M3-0.5
SB-4107	G-410	.350	.214	.161	M3-0.5
SB-4112	G-411	.500	.300	.196	6-32 UNC-2A
SB-4114	G-411	.500	.300	.194	M4-0.7
SB-4118	G-411	.500	.250	.188	6-32 UNC-2A

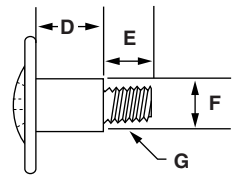
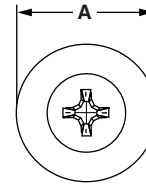

ISODAMP & VERSADAMP ISOLATORS

Plug Grommet

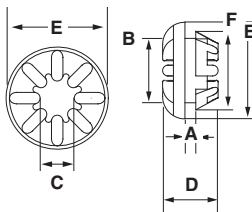

Pin Grommet

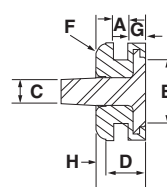
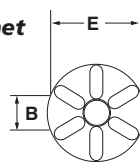

Corner Bumper

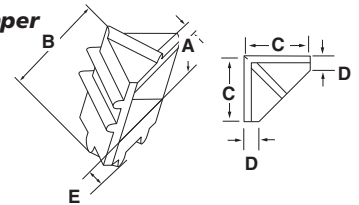

Family	Product	Dimensions (inches)					
		A Plate Thckns.	B Hole Diam.	C Inside Diam.	D Overall Height	E Outside Diam.	F Snap-fit Diam.
ISODAMP/VersaDamp	P-410	.057	.250	.158	.255	.379	.344
	P-411	.063	.375	.188	.323	.563	.457
	P-415	.039	.250	.158	.255	.379	.365

Dimensions (mm)

Family	Product	A	B	C	D	E	F	G	H
		Plate Thckns.	Hole Diam.	Pin Diam.	Grommet Height	Outside Diam.	Edge radius.	Lg Flg. Height	Sm Flg. Height
PIN GROMMETS	PG-100	1.5	6.4	2.5	5.0	9.8	1.27	1.75	1.75

Dimensions (mm)

Family	Product	A	B	C	D	E	F
		Drive Thckns.	Bumper Height	Bumper Length	Side Wall Thckns.	Bottom Wall Thckns.	Top Wall Thckns.
CORNER BUMPER	CB-100	5.0	9.75	6.00	1.5	1.5	3.25
	CB-101	5.0	8.00	6.75	1.5	1.5	1.50

For C-1002 material, indicate "-1" after part number (e.g. G-401-1)
 For C-1105 material, indicate "-2" after the part number (e.g. G-401-2)
 For C-1100 material, indicate "-3" after the part number (e.g. G-401-3)
 For C-8002 material, indicate "-8" after the part number (e.g. G-401-8)
 For VersaDamp material, indicate "formulation number" after the part number (e.g. G-401-2325)

Dimensions given here are nominal. Exact specification print available on request.

	C-1002	C-1105	C-1100	C-8002	VersaDamp
Grommet Color	Blue	Turquoise	Yellow	Sky Blue	Black
Peak Performance Temp. Range at 1000 Hz	55F-105F (13C-41C)	80F-130F (27C-54C)	95F-145F (35C-63C)	62F-105F (17C-41C)	-40F-122F (-40C-50C)

*Refer to page 19 for additional temperature data.



Aearo Technologies • a 3M company

www.earshockandvibe.com www.earsc.com
 E-mail: solutions@earsc.com

Toll-free hotline
 (877) EAR-IDEA
 (327-4332)

7911 Zionville Road
 650 Dawson Drive

Indianapolis, IN 46268
 Newark, DE 19713

Phone (317) 692-1111
 Phone (302) 738-6800

Fax (317) 692-3111
 Fax (302) 738-6811

PERFORMANCE CALCULATION GUIDE

HOW TO CALCULATE MOUNT STIFFNESS AND NATURAL FREQUENCY FOR ISODAMP AND VERSADAMP ISOLATORS

TEMPERATURE/FORMULATION CORRECTION CHART

Temperature F (C)	C-1002 Correction Factor	C-1105 Correction Factor	C-1100 Correction Factor	C-8002 Correction Factor	V-2325 Correction Factor	V-2590 Correction Factor	V-2599 Correction Factor	V-2750 Correction Factor
45F (7C)	8.58	—	—	31.61	0.53	1.85	2.18	1.30
50F (10C)	5.86	—	—	22.22	0.49	1.56	1.85	1.22
55F (13C)	2.80	8.26	—	15.33	0.46	1.24	1.9	1.15
60F (16C)	1.94	5.90	—	10.39	0.43	1.16	1.39	1.10
65F (18C)	1.39	4.28	—	7.95	0.41	1.07	1.27	1.07
70F (21C)	1.00	3.11	8.85	5.28	0.39	0.96	1.14	1.02
75F (24C)	.075	2.28	6.25	3.51	0.37	0.87	1.03	0.97
80F (27C)	0.56	1.70	4.45	2.38	0.35	0.80	0.95	0.91
85F (29C)	0.44	1.30	3.24	1.87	0.34	0.77	0.90	0.87
90F (32C)	0.35	1.00	2.36	1.34	0.33	0.72	0.84	0.81
95F (35C)	0.29	0.78	1.74	1.01	0.32	0.69	0.80	0.76
100F (38C)	0.25	0.63	1.30	0.80	0.32	0.66	0.77	0.71
105F (41C)	0.22	0.51	1.00	0.67	0.31	0.64	0.74	0.67
110F (43C)	0.20	0.42	0.77	0.61	0.31	0.63	0.73	0.65
115F (46C)	0.18	0.34	0.61	0.55	0.30	0.62	0.71	0.63
120F (49C)	0.17	0.29	0.49	0.50	0.30	0.61	0.70	0.61
125F (52C)	0.16	0.28	0.43	0.48	0.30	0.60	0.69	0.60
130F (54C)	0.16	0.27	0.41	0.47	0.30	0.59	0.68	0.60
135F (57C)	0.15	0.24	0.34	0.45	0.29	0.59	0.67	0.59
140F (60C)	0.15	0.22	0.30	0.44	0.29	0.58	0.66	0.58
145F (63C)	0.15	0.20	0.26	0.44	0.29	0.58	0.66	0.58
150F (66C)	0.14	0.19	0.23	0.43	0.29	0.57	0.66	0.58
155F (68C)	0.14	0.18	0.22	0.43	0.29	0.57	0.66	0.58
160F (71C)	0.14	0.17	0.20	0.43	0.29	0.57	0.65	0.58

Non-shaded area indicates peak damping performance temperature range.

Predicting E-A-R isolator performance is simple. Just follow the instructions below and refer to the grommet data tables and performance graphs beginning on Page 4.

DETERMINING DYNAMIC STIFFNESS

Select a candidate ISODAMP or VersaDamp grommet based on your application parameters—load per isolator, axial (horizontal plate) or radial (vertical plate) orientation, and plate dimensions. Follow these steps to determine a grommet's dynamic stiffness by using the data table and performance graph for the grommet style you have chosen.

- **From the data table**—Locate the load factor for the chosen grommet and orientation (axial or radial). Now, divide the grommet load (lb/grommet) by the load factor. The result is the load ratio.
- **To the performance graph**—Locate the load ratio value on the curve (x-axis), and read the resulting stiffness ratio from the y-axis.
- **Back to the data table**—Multiply this stiffness ratio value by the stiffness factor. And this is the per grommet stiffness (lb/in).

CORRECTION FOR ELASTOMER FORMULATION AND OPERATING TEMPERATURE

The stiffness calculated from the grommet data tables and

performance graphs represents the dynamic stiffness for a C-1002 grommet at 70F (21C). The Temperature/ Formulation Correction Chart above makes it easy to determine the dynamic stiffness of any ISODAMP or VersaDamp grommet for any operating temperature.

Simply multiply the correction factor from this chart by the stiffness just calculated to get the dynamic stiffness value (lb/in) of the grommet in the material of choice for your operating temperature range.

NATURAL FREQUENCY CALCULATION

Calculations from the grommet data tables and grommet performance graphs are intended to determine dynamic stiffness values for E-A-R grommets. This stiffness data is basic to predicting overall system response and system natural frequency.

The natural frequency of a particular E-A-R grommet can now be calculated using the following formula:

$$F_n = 3.13 \sqrt{K \div W}$$

WHERE: F_n = Natural frequency of the grommet (Hz)

K = Dynamic stiffness (lb/in)

W = Load per grommet (lb)



Aearo Technologies - a 3M company

www.earshockandvibe.com www.earsc.com
E-mail: solutions@earsc.com

Toll-free hotline
(877) EAR-IDEA
(327-4332)

7911 Zionsville Road
650 Dawson Drive

Indianapolis, IN 46268
Newark, DE 19713

Phone (317) 692-1111
Phone (302) 738-6800

Fax (317) 692-3111
Fax (302) 738-6811

Vibration Isolation

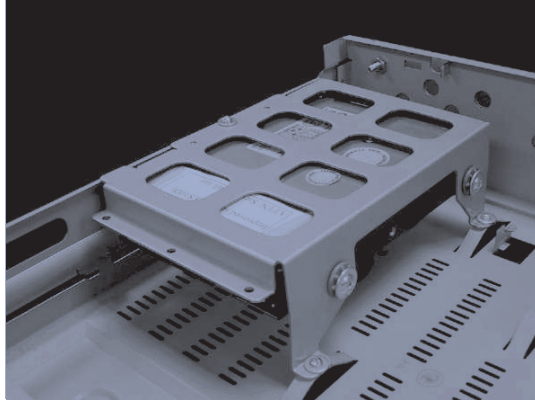

Figure 1

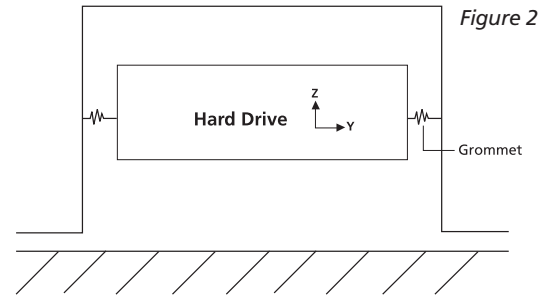

Figure 2

K = Dynamic stiffness (lb/in)
 W = Load per grommet (lb)

Natural Frequency (Hz)
 (resonance)

$$F_n = 3.13 \sqrt{K \div W}$$

Cross-Over Frequency
 (where isolation begins)

$$F_x = 4.42 \sqrt{K \div W} = \sqrt{2} F_n$$

Peak Transmissibility
 (maximum amplification)

$$T_{max} = \frac{\sqrt{1 + \eta^2}}{\eta}$$

EXAMPLE CALCULATION: COMPUTER HARD DRIVE

Problem Statement

• Our example is a 1.5 lb hard drive isolated with four G-411-2 (ISODAMP C-1105) grommets at 100F. Lateral hard drive vibration produces axial grommet deflection (y direction, see Figure 2). We therefore will utilize the axial mount data for the stiffness calculation. Four grommets will be used to support the hard drive. Two grommets are shown in Figure 1 and two are located on the opposite side.

Stiffness and Natural Frequency Calculation

- Load per grommet: $1.5 \text{ lb} \div 4 = 0.375 \text{ lb/grommet}$
- From the data table on Page 4: load factor = 1.8
- Divide load per grommet by load factor to get load ratio:
 $0.375 \div 1.8 = 0.208$
- Use the performance graph to determine the stiffness ratio: load ratio of 0.208 corresponds to stiffness ratio of 3.0
- From the data table: stiffness factor = 1911 lb/in
- Effective stiffness is stiffness factor x stiffness ratio: $1911 \text{ lb/in} \times 3 = 5733 \text{ lb/in}$
- Determine the temperature correction factor for C-1105 material @ 100F. Temperature correction factor=0.63.
- Actual grommet dynamic stiffness: $5733 \text{ lb/in} \times 0.63 = 3612 \text{ lb/in}$
- Natural Frequency $F_n = 3.13 \sqrt{(3612 \div 0.375)} = 307 \text{ Hz}$

Isolation Performance Calculation

- Cross-Over Frequency = $\sqrt{2} \times 307 = 434 \text{ Hz}$
- F_d = Resonant Frequencies to avoid in computer housings: 1000 to 2000 Hz.
- Frequency Ratio = $F_d / F_n = 1000 \text{ Hz} \div 307 \text{ Hz} \ \& \ 2000 \text{ Hz} \div 307 \text{ Hz} = 3.25 \ \& \ 6.5$
- Per the graph in Figure 3 using frequency ratios, there will be 0.3 to 0.15 Transmissibility (or 70 percent to 85 percent isolation) in that range
- To estimate peak transmissibility as shown in Figure 3, use loss factor from the material nomogram (Figure 4) and equation at left. ($\eta_m = 0.8, T_{max} = 1.6$)

Note: For instructions on how to read a material nomogram, see Page 18.

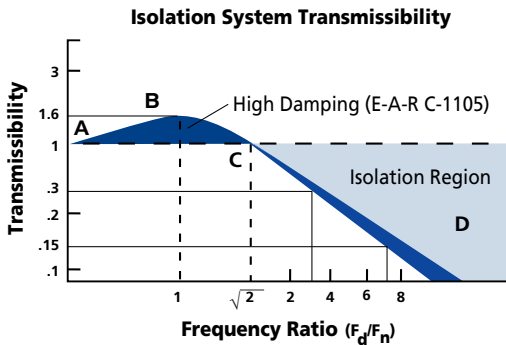

Figure 3

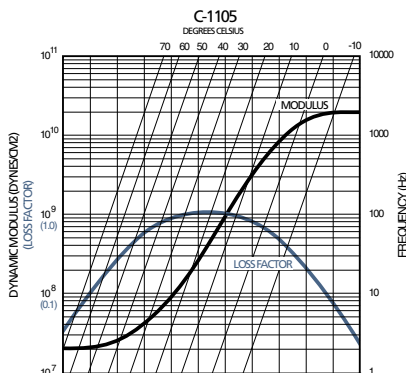

Figure 4



HOW TO CALCULATE SHOCK RESPONSE PERFORMANCE

Shock Protection

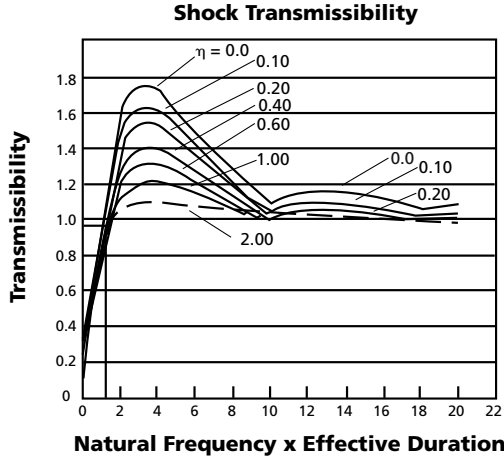

Figure 1

K = Dynamic stiffness (lb/in)
 W = Load per grommet (lb)

Natural Frequency (rad/sec)
 (resonance)

$$\omega_n = 19.65 \sqrt{K \div W}$$

Shock Input: Half Sine
(100G, 2ms)

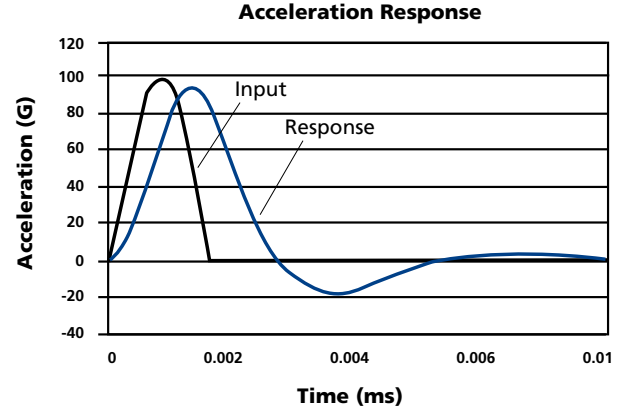

Figure 2

COMPUTER HARD DRIVE SHOCK PROTECTION

Problem Statement

• Our example is a 1.5 lb hard drive isolated with four G-411-2 grommets at 100F. The shock input: Half Sine 100G @ 2ms. The shock input creates radial loading of grommets (z direction in Figure 2, Page 11). Therefore, we will utilize radial mount data for our stiffness calculation. Four grommets are used to support the hard drive (see Figure 1, Page 11).

Stiffness and Natural Frequency Calculation

- Load per grommet: $1.5 \text{ lb} \div 4 = 0.375 \text{ lb/grommet}$
- From the data table on Page 4: load factor = 0.9
- Divide load per grommet by load factor to get load ratio: $0.375 \div 0.9 = 0.417$
- Use the performance graph to get the stiffness ratio: load ratio of 0.417 corresponds to stiffness ratio of 1.5
- From the data table: stiffness factor = 1153 lb/in
- Effective stiffness will be stiffness factor x stiffness ratio = $1.5 \times 1153 = 1730 \text{ lb/in}$
- Determine the temperature correction factor for C-1105 material @ 100F. Temperature correction factor = 0.63.
- Actual grommet dynamic stiffness: $1730 \text{ lb/in} \times 0.63 = 1090 \text{ lb/in}$
- Natural Frequency $\omega_n = 1059 \text{ rad/sec}$ (167 Hz)

Shock Protection Performance Calculation

- Effective time duration for half sine shock is 0.637 x actual duration: $0.637 \times 0.002 \text{ sec} = 0.00127 \text{ sec}$
- Take natural frequency x effective duration = $1059 \text{ rad/sec} \times 0.00127 \text{ sec} = 1.35$ and find response in Figure 1 using loss factor = 1.0 curve.
- Transmissibility is just slightly less than one. Calculated time response (via computer algorithm) in Figure 2 confirms this. Often, this is quite acceptable where the designer wants to ensure that the system does not amplify shock.
- Peak deflection for this system is 0.022 inch as determined from graph in Figure 3 using the C-1105 material. A curve is shown for poorly damped material such as natural rubber ($\eta_m = 0.1$). The peak displacement would then be 0.039 inch which is 77 percent higher than the ISODAMP C-1105 material. This graph is valid for 100G, 2ms half sine pulses only.
- Additional theory on shock protection calculations can be found in most shock and vibration handbooks.

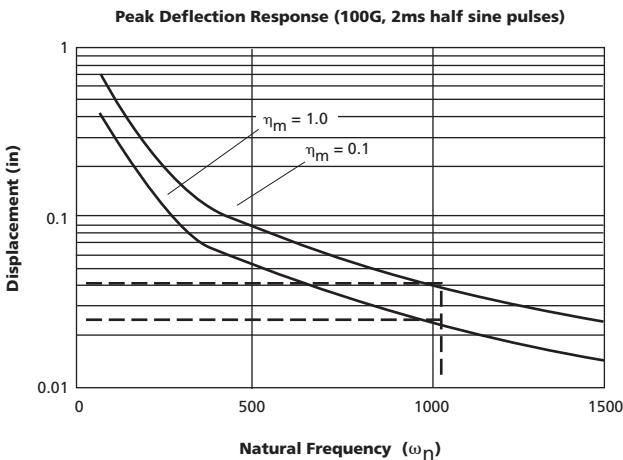
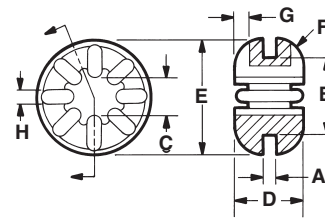

Figure 3

**Symmetric,
Internally Ribbed**



SYMMETRIC, INTERNALLY RIBBED GROMMETS

Part No.	Dynamic Stiffness (lbin)		Load (lb) Recommended Maximum	Dimensions (inches)							
	Axial	Radial		A Plate Thckns.	B Hole Diam.	C Inside Diam.	D Overall Height	E Outside Diam.	F Edge Radius	G Rib Height	H Rib Width
G-411-H	1470	887	6.0	.063	.375	.188	.313	.555	.125	.063	.063
G-411-SL20100	226	110	1.0	.059	.375	.188	.308	.555	.123	.059	.063
G-411-SL25200	318	154	1.0	.059	.375	.188	.308	.555	.123	.059	.063

Shear

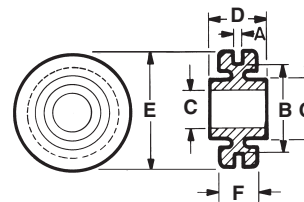

SHEAR GROMMETS

Part No.	Dynamic Stiffness (lbin)		Load (lb) Recommended Maximum	Dimensions (inches)							
	Axial	Radial		A Plate Thckns.	B Hole Diam.	C Inside Diam.	D Overall Height	E Outside Diam.	F Flange Thckns.	G Boss Out. Diam.	H Rib Width
G-601-H	294	557	2.0	.056	.565	.245	.375	.750	.237	.375	n/a
G-601-SL20100	57	111	.3	.050	.569	.245	.380	.755	.245	.380	n/a
G-601-SL25200	67	131	.3	.050	.569	.245	.380	.755	.245	.380	n/a

Equipment Mounts

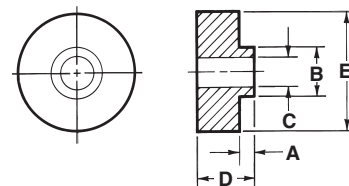

EQUIPMENT MOUNTS

Part No.	Load (lb) Recommended Maximum	Dimensions (inches)							
		A Shank Height	B Shank Diam.	C Inside Diam.	D Overall Height	E Flange Diam.	F Flange Thckns.	G Boss Out. Diam.	H Rib Width
ML-4250-H	70.0	.125	.495	.309	.629	1.169	n/a	n/a	n/a
ML-4250-SL20100	10.0	.126	.500	.313	.625	1.165	n/a	n/a	n/a
ML-4250-SL25200	10.0	.126	.500	.313	.625	1.165	n/a	n/a	n/a

"H" after part number indicates ISOLOSS HD material; "V" after part number indicates ISOLOSS VL material.
Dimensions given here are nominal. Exact specification print available on request.

ISOLOSS MOUNTS

MALE-MALE / MALE-BLANK SANDWICH MOUNTS

Male-Male Sandwich Mounts

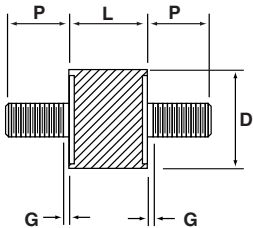

Male-Blank Sandwich Mounts

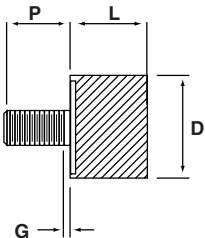

Part No.	Dynamic Stiffness (lbin)		Load (lbs)		Dimensions		Threads			
	Compression	Shear	Max. Compressive	Max. Shear	D Diam. (in)	L Length (in)	Type	P Overall Height	G Grip (in)	T _D Depth (in)
MM-100-UC04-H	262	59	4.0	1.5	.275	.320	#4-40	.200	.060	n/a
MM-100-UC04-SL20100	126	12	0.5	0.2	.280	.320	#4-40	.200	.060	n/a
MM-100-UC04-SL25200	185	15	0.5	0.2	.280	.320	#4-40	.200	.060	n/a
MM-200-UC06-H	285	74	8.0	3.0	.400	.500	#6-32	.375	.060	n/a
MM-200-UC06-SL20100	133	12	1.0	0.4	.405	.500	#6-32	.375	.060	n/a
MM-200-UC06-SL25200	133	15	1.0	0.4	.405	.500	#6-32	.375	.060	n/a
MM-200-UC08-H	285	74	8.0	3.0	.400	.500	#8-32	.375	.060	n/a
MM-200-UC08-SL20100	108	12	1.0	0.4	.405	.500	#8-32	.375	.060	n/a
MM-200-UC08-SL25200	152	15	1.0	0.4	.405	.500	#8-32	.375	.060	n/a
MM-300-UC25-H	471	120	20.0	5.0	.615	.625	1/4-20	.500	.100	n/a
MM-400-UC31-H	1108	270	50.0	13.0	1.00	.750	5/16-18	.625	.100	n/a
MB-100-UC04-H	262		4.0		.275	.320	#4-40	.200	.060	n/a
MB-100-UC04-SL20100	96	n/a	0.5	n/a	.280	.320	#4-40	.200	.060	n/a
MB-100-UC04-SL25200	132	n/a	0.5	n/a	.280	.320	#4-40	.200	.060	n/a
MB-200-UC06-H	285		8.0		.400	.500	#6-32	.375	.060	n/a
MB-200-UC06-SL20100	116	n/a	1.0	n/a	.405	.500	#6-32	.375	.060	n/a
MB-200-UC06-SL25200	133	n/a	1.0	n/a	.405	.500	#6-32	.375	.060	n/a
MB-200-UC08-H	285		8.0		.400	.500	#8-32	.375	.060	n/a
MB-200-UC08-SL20100	101	n/a	1.0	n/a	.405	.500	#8-32	.375	.060	n/a
MB-200-UC08-SL25200	139	n/a	1.0	n/a	.405	.500	#8-32	.375	.060	n/a
MB-300-UC25-H	471		20.0		.615	.625	1/4-20	.500	.100	n/a
MB-400-UC31-H	1108		50.0		1.00	.750	5/16-18	.625	.100	n/a

INSTALLATION HINTS

SEE PAGE 17

MALE-FEMALE / FEMALE-BLANK SANDWICH MOUNTS

Male-Female Sandwich Mounts

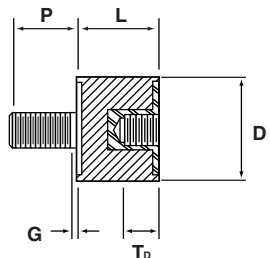

Female-Blank Sandwich Mounts

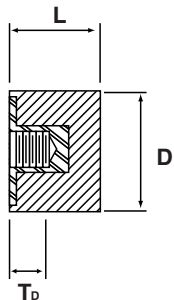

Part No.	Dynamic Stiffness (lbin)		Load (lbs)		Dimensions		Threads			
	Compression	Shear	Max. Compressive	Max. Shear	D Diam. (in)	L Length (in)	Type	P Overall Height	G Grip (in)	T _D Depth (in)
MF-100-UC04-H	765	148	2.0	0.8	.275	.320	#4-40	.200	.060	.110
MF-100-UC04-SL20100	205	20	0.3	0.1	.280	.320	#4-40	.200	.060	.110
MF-100-UC04-SL25200	154	22	0.3	0.1	.280	.320	#4-40	.200	.060	.110
MF-200-UC06-H	1049	208	4.0	2.0	.400	.500	#6-32	.375	.060	.160
MF-200-UC06-SL20100	242	19	0.6	0.3	.405	.500	#6-32	.375	.060	.160
MF-200-UC06-SL25200	428	22	0.6	0.3	.405	.500	#6-32	.375	.060	.160
MF-200-UC08-H	1049	208	4.0	2.0	.400	.500	#8-32	.375	.060	.160
MF-200-UC08-SL20100	242	18	0.6	0.3	.405	.500	#8-32	.375	.060	.160
MF-200-UC08-SL25200	270	22	0.6	0.3	.405	.500	#8-32	.375	.060	.160
MF-300-UC25-H	2350	385	12.0	3.5	.615	.625	1/4-20	.500	.100	.260
MF-400-UC31-H	6727	896	45.0	10.0	1.00	.750	5/16-18	.625	.100	.290
FB-100-UC04-H	765		2.0		.275	.320	#4-40	n/a	n/a	.110
FB-100-UC04-SL20100	159	n/a	0.3	n/a	.280	.320	#4-40	n/a	n/a	.110
FB-100-UC04-SL25200	169	n/a	0.3	n/a	.280	.320	#4-40	n/a	n/a	.110
FB-200-UC06-H	1049		4.0		.400	.500	#6-32	n/a	n/a	.160
FB-200-UC06-SL20100	228	n/a	0.6	n/a	.405	.500	#6-32	n/a	n/a	.160
FB-200-UC06-SL25200	123	n/a	0.6	n/a	.405	.500	#6-32	n/a	n/a	.160
FB-200-UC08-H	1049		4.0		.400	.500	#8-32	n/a	n/a	.160
FB-200-UC08-SL20100	186	n/a	0.6	n/a	.405	.500	#8-32	n/a	n/a	.160
FB-200-UC08-SL25200	198	n/a	0.6	n/a	.405	.500	#8-32	n/a	n/a	.160
FB-300-UC25-H	2530		12.0		.615	.625	1/4-20	n/a	n/a	.260
FB-400-UC31-H	6727		45.0		1.00	.750	5/16-18	n/a	n/a	.290

"H" after part number indicates ISOLOSS HD material.

Dimensions given here are nominal. Exact specification print available on request.



Aearo Technologies - a 3M company

www.earshockandvibe.com www.earsc.com
E-mail: solutions@earsc.com

Toll-free hotline
(877) EAR-IDEA
(327-4332)

7911 Zionsville Road

Indianapolis, IN 46268

Phone (317) 692-1111

Fax (317) 692-3111

650 Dawson Drive

Newark, DE 19713

Phone (302) 738-6800

Fax (302) 738-6811

ISOLOSS PERFORMANCE CALCULATION GUIDE

WORKSHEET TO DETERMINE ISOLATOR STIFFNESS AND NATURAL FREQUENCY

The dynamic stiffness values presented in the tables on Pages 13-14 are based on a mount temperature of 68F (20C). To determine whether a particular ISOLOSS HD or VL isolator has the required dynamic stiffness for a particular application, simply use the Stiffness-Temperature Correction Graph below and follow these steps.

CALCULATING STIFFNESS WITH TEMPERATURE

1. Select an ISOLOSS HD or VL isolator for your application.
2. Consult the tables on Pages 13-14 to find the dynamic stiffness value for the particular isolator you have chosen. Use the value given for either *axial* (horizontal plate) or *radial* (vertical plate), depending on how the grommet will be used. For a sandwich mount, choose the value for *compression* or *shear* mounting.
3. Using the operating temperature of the application, find the temperature correction factor for the material you are considering from the graph below.
4. Multiply the dynamic stiffness value by the temperature correction factor to obtain the dynamic stiffness at the specified temperature of the application.

NATURAL FREQUENCY CALCULATION

The natural frequency of a particular E-A-R grommet or sandwich mount can now be calculated by using the dynamic stiffness calculated above.

$$F_n = 3.13 \sqrt{K \div W}$$

WHERE: F_n = Natural frequency of the grommet (Hz)

K = Dynamic stiffness (lb/in)

W = Load per grommet (lb)

Refer to Pages 11 and 12 for remainder of isolator performance calculations.

CALCULATION WORKSHEET

1. Choice of isolator _____
2. Weight/isolator _____
3. Orientation of the installed isolator _____
4. Dynamic stiffness of the isolator at 68F (20C) _____
5. Operating temperature of the application _____
6. Temperature correction factor _____
7. Multiply the dynamic stiffness value _____ (lb/in)
by the temperature correction factor
8. Calculate natural frequency using equation provided below left.

EXAMPLE CALCULATION

1. Choice of isolator G-411-H
2. Weight per isolator = 3 lbs.
3. Orientation of the installed isolator Axial mount
4. Dynamic stiffness of the isolator at 68F (20C) = 1470
5. Operating temperature of the application = 86F (30C)
6. Temperature correction factor = 0.5
7. Multiply by the dynamic stiffness value = 735 lb/in
by the temperature correction factor
8. Calculate natural frequency: $F_n = 3.13 \sqrt{735/3} = 49\text{Hz}$
9. Refer to Pages 11 and 12 for additional isolator performance calculations.

STIFFNESS-TEMPERATURE CORRECTION GRAPH

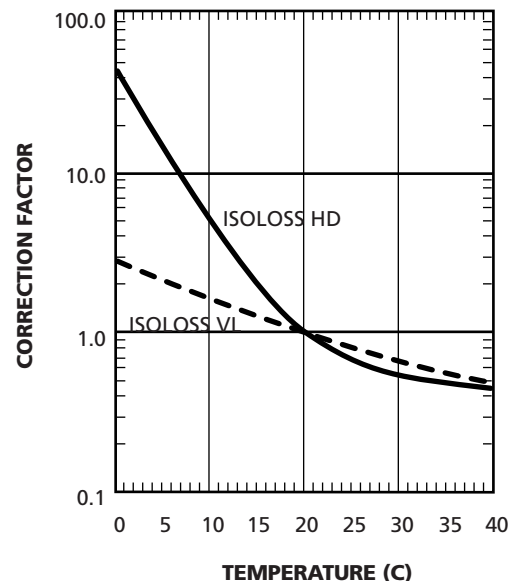

ISOLATOR INSTALLATION HINTS

GROMMET INSERTION

Figure 1

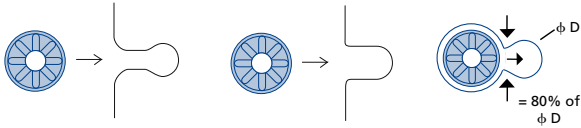

TYPICAL ISODAMP GROMMET INSTALLATIONS

Figure 2

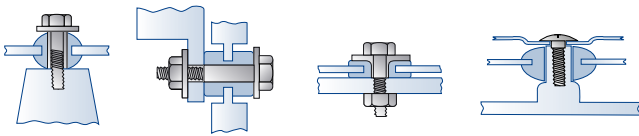

TYPICAL ISODAMP BUSHING AND RING INSTALLATIONS

Figure 3

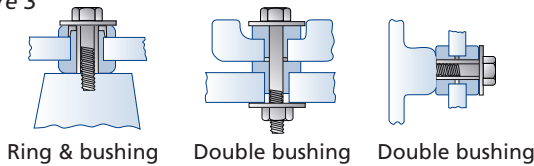

RECOMMENDED HARDWARE TO OPTIMIZE PERFORMANCE

Figure 4

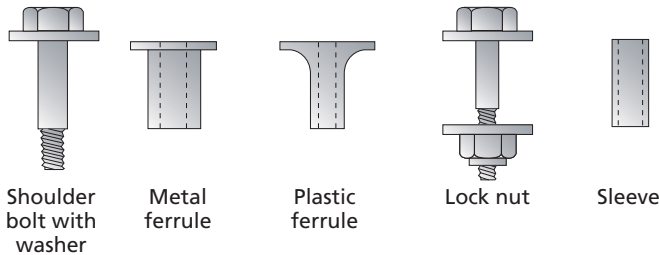

FOR PRELOAD CALCULATION

Figure 5

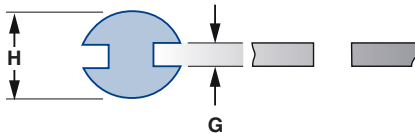

FAN MOUNT INSTALLATION

Figure 6

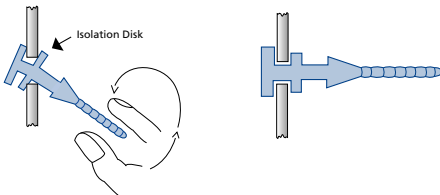
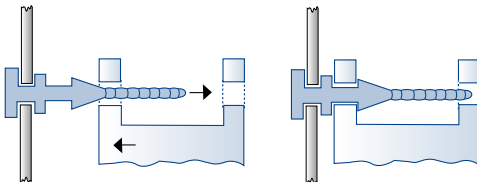

Figure 7



GROMMETS

To meet a wide range of performance and assembly needs, E-A-R offers both one-piece and two-piece styles of grommets.

One-piece grommets—ribbed and non-ribbed

Here are typical methods for installing one-piece E-A-R grommets in a frame or panel.

- For use in automated assembly, the preferred method of grommet installation is the straight-side or keyhole slot. See Figure 1. This method accommodates robotic assembly and is the easiest for manual assembly as well. Using this method, the grommet and the hardware recommended to optimize performance can be installed in a single step, or the hardware can be added later. See Figure 2.

- For manual assembly without keyhole slots, E-A-R grommets can be heated to make them more pliable. They can then more easily be pushed into position in the frame or plate.

Two-piece grommets—bushings and rings

For non-standard-thickness panels or frames, use of two-piece grommets (bushings and rings, or two bushings, as shown in Figure 3) can provide a major installation advantage. Two-piece grommets eliminate the need for preheating. The two pieces are installed from opposite sides to accommodate many panel thicknesses.

Hardware

Common hardware, typically used with E-A-R grommets to mechanically limit preload, is shown in Figure 4. The hardware may include a shoulder bolt with washer, plastic or metal spacer, sleeve, or locking nuts with bolt and washers.

Optimum performance of vibration and shock is generally achieved with 5 to 10 percent preloading of E-A-R grommets, especially for ribbed styles. The ideal hardware height to obtain maximum recommended preload can be calculated from the formula **Hardware Height = 0.91 (H) + 0.09(G)**, where **H** is the overall grommet height and **G** is the thickness of the mounting plate. See Figure 5.

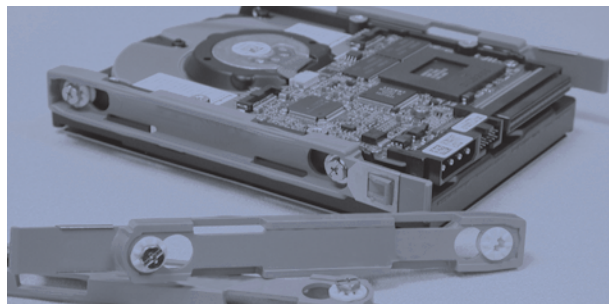

FAN MOUNTS

Here are typical methods for installing ISODAMP fan mounts.

- Pull one opening of the "isolation disk" into the hole in the sheet metal. Pull the fan mount into sheet metal hole in a rotational motion. See Figure 6. Repeat until all the fan mounts are in all the sheet metal holes.
- Align all the fan holes to the fan mounts. Push the fan into the fan mounts while pulling the tip of each individual fan mount through the holes in the fan. See Figure 7.

E-A-R

Aearo Technologies • a 3M company

www.earshockandvibe.com www.earsc.com
E-mail: solutions@earsc.com

Toll-free hotline
(877) EAR-IDEA
(327-4332)

7911 Zionsville Road

Indianapolis, IN 46268

Phone (317) 692-1111

Fax (317) 692-3111

650 Dawson Drive

Newark, DE 19713

Phone (302) 738-6800

Fax (302) 738-6811

Alternate fan mount installations

Figures 8 and 9 illustrate two alternate installation methods.

- **Basic Keyhole:** Slide fan mounts into the keyholes on the sheet metal. Align all the fan holes to the fan mounts. Push the fan into the mounts, pulling each mount through the corresponding hole in the fan. See Figure 8.
- **Rotational Keyhole:** First pull all the fan mounts through the holes on the fan. Position the fan and mount assembly over the sheet metal. Push all the fan mount bases into the large portion of the keyhole. Rotate the assembly until it locks in place. See Figure 9.

Custom design options

E-A-R fan mounts can be designed with a throw-away tip that breaks away with a firm tug after the fan has been installed. See Figure 10. The force required to pull the mount through the fan holes should be less than 1.5 lbf. Break-off force for the tip is about 3 lbf. Figure 11 shows another option—a “double Xmas tree design”— which can accommodate two different flange thicknesses.

For even greater flexibility in manufacturing assembly, fan mounts can be designed for two-way pull-through installation. See Figure 12. This allows the choice of pulling the mount through either the fan holes or the sheet metal holes first.

ISOLOSS SANDWICH MOUNTS

As shown in Figure 13, ISOLOSS sandwich mounts can be used to support loads in either compression or shear, or, as in most cases, some combination of the two. Here are some installation tips to consider when installing a mount.

Loading conditions vs. stiffness

ISOLOSS HD and VL elastomers are stiffer under compressive load than under shear load. Consequently, when the elastomers are used in shear, they cannot be load-rated as highly as when used in compression.

The dynamic shear stiffness generally is between 20 and 30 percent of the compressive stiffness. Thus, a mount's natural frequency under compression loading is twice what it is under shear loading. Therefore, a mount can be used in static compression up to its material strength limits while providing very good isolation of lateral, or shear, vibration.

Deflection in overload conditions

ISOLOSS sandwich mounts are self-snubbing under compressive overload. As a mount is loaded to its design limit, the effective stiffness begins to increase, thus offsetting excessive deflection under overload conditions. By contrast, overload in the shear direction will increase shear stiffness only slightly. Consequently, shear overload is not self-snubbing. The same is true for tensile overload.

This behavior makes a strong case for engineering sandwich mounts to be used primarily in compression, especially in cases where occasional overload or excessive temperatures may occur. As a rule, sandwich mounts should never be used primarily in tension. If they must be used in tension or shear, however, a fail-safe design, e.g., use of a retention strap, is especially critical.



ALTERNATE INSTALLATION

Figure 8: Basic Keyhole

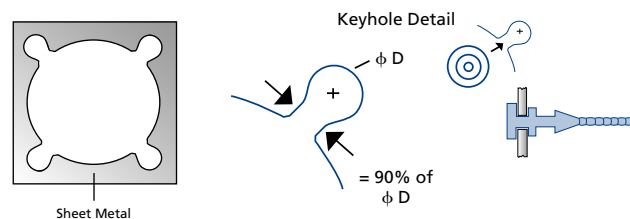
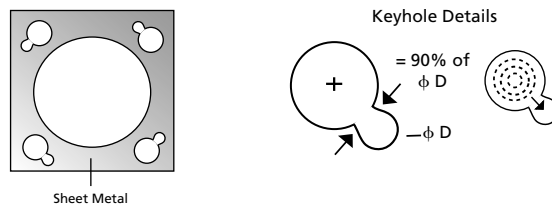

Figure 9: Rotational Keyhole



CUSTOM FAN MOUNT DESIGN OPTIONS

Figure 10: Break-off Tip

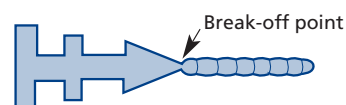

Figure 11: Double X-mas Tree

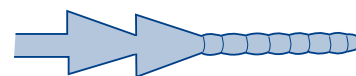
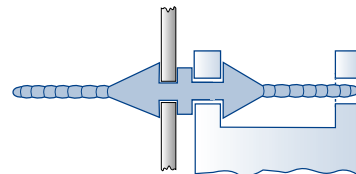
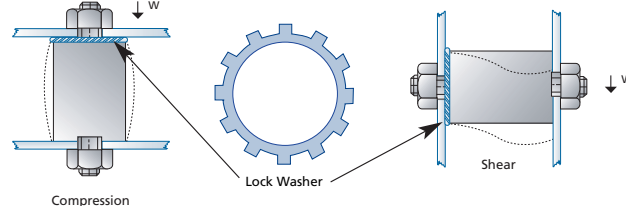

Figure 12: 2-Way Pull Through



SANDWICH MOUNT

Figure 13



C-1000 Series

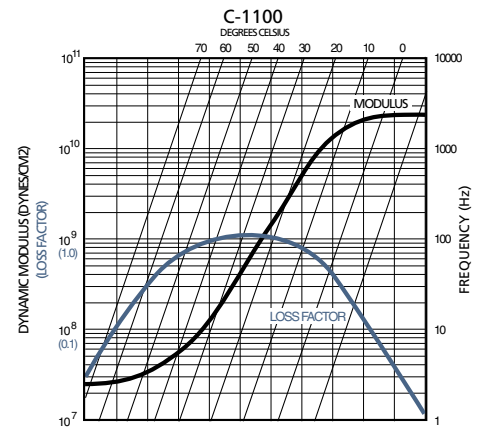
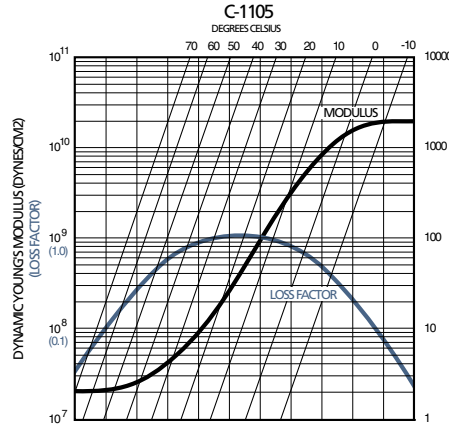
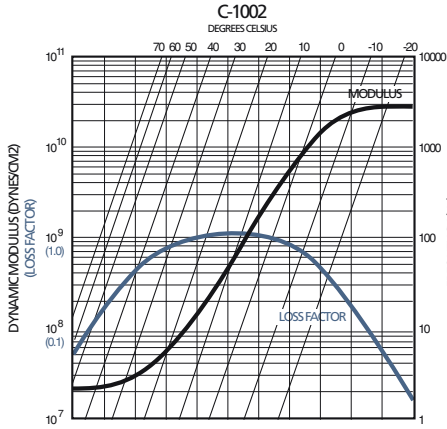

VERSADAMP

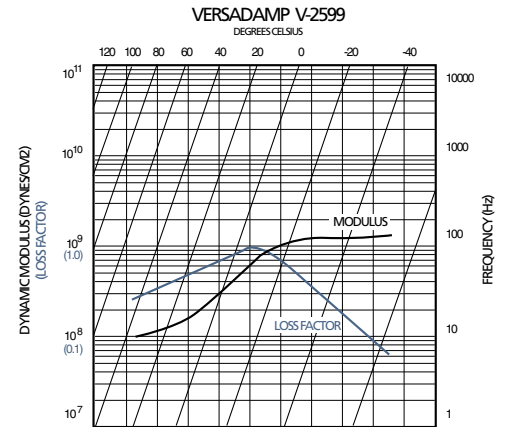
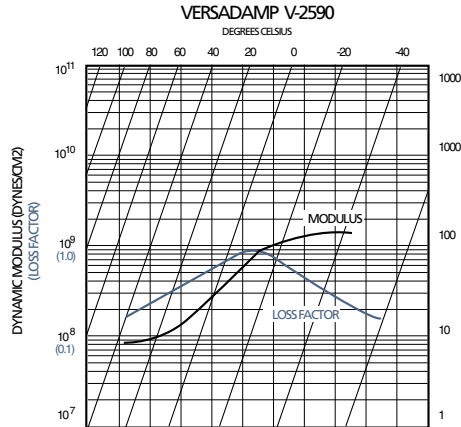
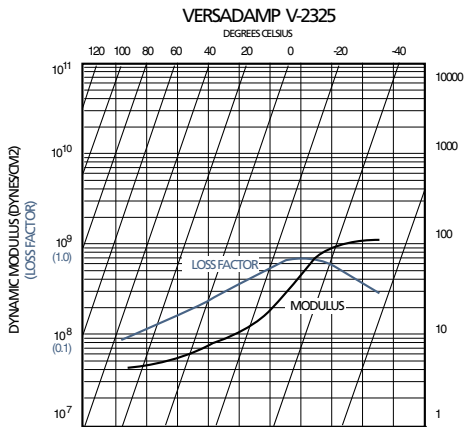

ISOLOSS HD

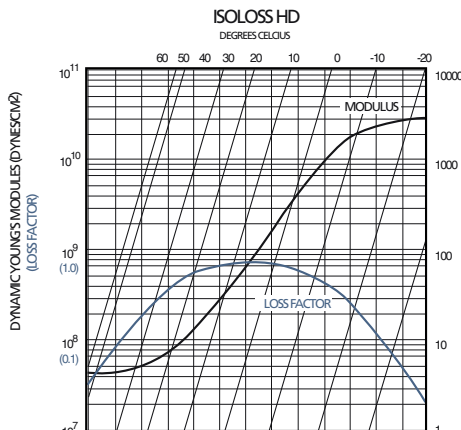
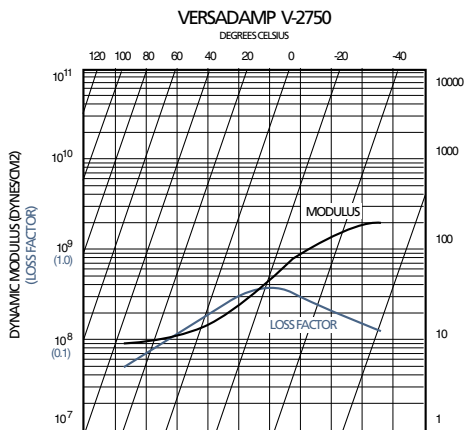

Reduced Frequency Nomograms

The reduced frequency format is the standard method for displaying damping material performance data. To determine dynamic Young's modulus and material loss factor at a given temperature and frequency, use the following steps.

- 1) Select the frequency of interest on the right-hand vertical axis.
- 2) Follow the selected frequency line horizontally to the left until the selected *diagonal* temperature isotherm is intersected.
- 3) Draw a vertical line up and down through the frequency/isotherm intersection, intersecting the dynamic Young's modulus and material loss factor curves.
- 4) Draw horizontal lines from these points to intersect the left-hand vertical axis.
- 5) The dynamic Young's modulus value is read using the Dynamic Modulus scale and the loss factor from the Loss Factor scale.

Note: Downloadable versions of these nomograms are available on our Websites.



Aearo Technologies - a 3M company

www.earshockandvibe.com www.earsc.com
E-mail: solutions@earsc.com

Toll-free hotline
(877) EAR-IDEA
(327-4332)

7911 Zionsville Road
650 Dawson Drive

Indianapolis, IN 46268
Newark, DE 19713

Phone (317) 692-1111
Phone (302) 738-6800

Fax (317) 692-3111
Fax (302) 738-6811

TYPICAL PROPERTIES

Property	ISODAMP				VersaDamp			ISOLOSS			
	C-1002	C-1105	C-1100	C-8002	V-2325	V-2590	V-2599	ISOLOSS HD	SL-20100	SL-25200	
Description	Vinyl Solid	Vinyl Solid	Vinyl Solid	TPE Solid	TPR Solid	TPR Solid	TPR Solid	Urethane Solid	Synthetic Rubber	Synthetic Rubber	
Hardness											
ASTM D2240											
Shore A Durometer 23C (73F)											
On Impact									58		
5 sec impact							57	50			
15 sec impact	56	63	70	57	40				21	27	
Flammability											
UL 94	Listed V-0 @ 0.072 cm (0.28 in)	Listed V-0 @ 0.15 cm (0.06 in)	Listed V-0 @ 0.15 cm (0.06 in)	Listed V-0 @ 0.28 cm (0.110 in)				Listed HB @ 0.32 cm (0.125 in)	Listed HB @ 0.15 cm (0.06 in)		
MVSS-302	Meets at 0.040 cm (0.015 in)		Meets at 0.15 cm (0.06 in)	Meets at 0.32 cm (0.125 in)	Meets at 0.32 cm (0.125 in)	Meets at 0.32cm (0.125 in)	Meets at 0.32 cm (0.125 in)	Meets at 0.32 cm (0.125 in)			
FAR 25.853 (a) Appendix F Part I (a) (1) (ii) (12 sec)	Meets at .152 cm (.060 in)										
Canadian Stds. Assoc. (CSA)	Listed 0.6 V-0 0.15 cm (0.06 in)		Listed 0.6 V-0 0.15 cm (0.06 in)						Listed 0.6 HB 0.32 cm (0.06 in)		
Compression Load											
Deflection kPa (psi)											
ASTM D575											
at 0.51 cm/min (0.2 in/min)											
10% kPa (psi)	490 (71)	634 (92)	1069 (155)	751 (109)	210 (30)	551 (80)	469 (68)	565 (82)	124 (18)	179 (26)	
20% kPa (psi)	1682 (244)	2206 (320)	3413 (495)	1530 (222)	450 (65)	1102 (160)	855 (124)	1241 (180)	241 (35)	352 (51)	
30% kPa (psi)	3682 (534)	4785 (694)	7122 (1033)	2440 (354)	817 (118)	1719 (249)	1448 (210)	2103 (305)	393 (57)	565 (82)	
Compression Set (%)											
ASTM D395 Method B											
22 hr at 22C (72F)	14	23	24	18	15	15	16	4.5	3	5	
22 hr at 70C (158F) *50C (122F)	62	51	55	66*	26	26	32	6.1	8	8	
22 hr at 90C (194F)							30	7.9			
Tensile Strength kPa (psi)											
ASTM D412	10852 (1574)	12459 (1807)	14190 (2058)	7930 (1150)	2620 (380)	4502 (653)	4930 (715)	8963 (1300)	3653 (530)	4384 (636)	
Tear Strength kN/m (lbf/in)											
ASTM D624	35 (202)	42 (241)	53 (305)	30 (173)	10.2 (58)	23.1 (132)	21.5 (123)	38 (218)	12.2 (69)	15.6 (88)	
Temperature Range C (F)									@1,000 HZ	@1,000 HZ	
Peak Damping	13C to 41C	27C to 54C	35C to 63C	17C to 41C	-40C to 50C	-40C to 50C	-40C to 50C	13C to 41C	8C to 51C	8C to 45C	
Performance Temperature Range	(55F to 105F)	(80F to 130F)	(95F to 145F)	(62F-105F)	(-40F to 122F)	(-40F to 122F)	(-40F to 122F)	(55F to 105F)	(46F to 123F)	(46F to 113F)	
Recommended Maximum	82C	82C	82C	80C	125C	125C	125C	107C	100C	100C	
Intermittent Temperature	(180F)	(180F)	(180F)	(176F)	(257F)	(257F)	(257F)	(225F)	(212F)	(212F)	
Maximum Continuous	70C	70C	70C	70C	100C	100C	100C	90C	70C	70C	
Service Temperature	(158F)	(158F)	(158F)	(158F)	(212F)	(212F)	(212F)	(194F)	(158F)	(158F)	
RoHS Compliant	Yes	Yes	Yes	Yes	Yes	Yes	Yes	Yes	Yes	Yes	



Acara Technologies - a 3M company

www.earshockandvibe.com www.earsc.com
E-mail: solutions@earsc.com

Toll-free hotline
(877) EAR-IDEA
(327-4332)

7911 Zionsville Road
650 Dawson Drive

Indianapolis, IN 46268
Newark, DE 19713

Phone (317) 692-1111
Phone (302) 738-6800

Fax (317) 692-3111
Fax (302) 738-6811

ELASTOMER COMPARISON GUIDE

	E-A-R Highly Damped Materials					Other Common Materials					
	VersaDamp V-2590	ISODAMP	ISODAMP C-8002	ISOLOSS HD	ISOLOSS HDF	Other TPE	Urethane Thermoset	Butyl Rubber	Natural Rubber	Neoprene	Nitrile Rubber
Damping T max (dB)	7	3	3	4	4	15	4	8.6	23	20	18
Durometer Shore A	57	56,63,70	57	58	61	55	35	55	50	50	55
Resilience %	12	5.3	4	4.5	4.5	49	4.8	15.6	68	238	28.4
Tensile Strength PSI	653	1574, 1807, 2058	1150	1300	1348	674	225	786	1741	584	1103
Percent Elongation	344	459	754	424	424	396	400	335	776	675	669
Tear Strength	Good	Excellent	Good	Excellent	Excellent	Poor	Fair	Good	Excellent	Good	Good
Abrasion Resistance	Poor	Good	Poor	Excellent	Excellent	Poor	Poor	Good	Excellent	Good to Excellent	Excellent
Compression Set Resistance	Good	Fair	Fair	Excellent	Excellent	Good	Excellent	Fair	Good	Fair to Good	Good
Low Temperature Embrittlement Point	-70C	-20C	-12C	-27C	-27C	-70C	-50C	-50C	-80C	-45C	-85C
High Temperature Max Intermittent	125C	82C	80C	107C	107C	125C	82C	135C	121C	135C	125C
Heat Aging 100C	Excellent	Good to Excellent	Good	Fair to Good	Fair to Good	Excellent	Fair to Good	Excellent	Good	Good	Good
Flame resistance	UL 94 HB	UL 94 V-0	UL 94 V-0	UL 94 HB	UL 94 V-2	UL 94 HBF	Poor to Fair	Poor	Poor	Good	Poor to Fair
Typical Process Method	Injection Molding	Injection Molding	Injection Molding	Transfer Molding	Transfer Molding	Injection Molding	Reaction Mold or Cast	Compression Mold	Compression Mold	Compression Mold	Compression Mold
Bonding	Poor	Fair	Excellent	Good	Good	Poor	Fair to Good	Fair to Excellent	Excellent	Good to Excellent	Excellent
Weather	Excellent	Good to Excellent	Excellent	Excellent	Excellent	Excellent	Excellent	Excellent	Fair	Excellent	Good
Oxidation	Excellent	Excellent	Excellent	Excellent	Excellent	Excellent	Excellent	Excellent	Good	Good	Fair to Good
Resistance Data	Ozone	Excellent	Good	Excellent	Excellent	Excellent	Excellent	Excellent	Poor	Excellent	Poor
	Water	Good	Excellent	Excellent	Good	Good	Good	Excellent	Excellent	Good	Excellent
	Acid	Excellent	Excellent	Good	Good	Good	Excellent	Poor to Fair	Excellent	Fair to Good	Good
	Alkali	Excellent	Good	Good	Good	Good	Excellent	Poor to Fair	Excellent	Fair to Good	Good
Gasoline, Kerosene, Etc. (Aliphatic Hydrocarbons)	Poor	Good	Poor	Excellent	Excellent	Poor	Excellent	Poor	Poor	Good	Excellent
Benzol, Toluol, Etc. (Aromatic Hydrocarbons)	Poor	Fair	Poor	Poor	Poor	Poor	Poor to Fair	Fair to Good	Poor	Poor	Good
Alcohol	Good	Poor	Good	Fair	Fair	Good	Good	Excellent	Good	Fair	Excellent
Degreaser Solvents (Halogenated Hydrocarbons)	Poor	Fair to Poor	Poor	Fair to Poor	Fair to Poor	Poor	Fair to Poor	Poor	Poor	Poor	Poor

PUT E-A-R ON YOUR DESIGN TEAM

Incorporating preventive measures early in a product's development process can help sidestep unwanted noise and vibration, as well as disruptive and destructive shock energy that can affect marketability. It also can prevent the need to re-engineer, redesign or retool. Retrofitting is rarely as cost-effective as designed-in controls, and may be much more costly to implement in the long run.

E-A-R engineers and technicians routinely consult with product designers about materials selection, design configurations, potential problems and other critical noise, vibration and shock issues while the design is still on the drawing board. We don't supply just materials. We offer our technical expertise, applications experience and testing capabilities as well.

Assistance from an E-A-R applications engineer may entail a quick phone call, complete in-house lab diagnosis or even a visit to the customer's site. Our NOVICON lab can effectively diagnose problems and validate our proposed solutions, utilizing state-of-the-art diagnostic and analytical tools. Vibration shakers, drop shock tables, high-speed video and a hemi-anechoic chamber are just a few of the tools commonly used.

E-A-R also utilizes the latest 3D solid modeling CAD systems—ProE, CATIA, SolidWorks and SDRC-Ideas—to examine a customer's product during the design stage and to develop custom solutions. Electronic transfer of large files is available through our Websites.

The data listed in this guide are typical or average values based on tests conducted by independent laboratories or by the manufacturer. They are indicative only of the results obtained in such tests and should not be considered as guaranteed maximums or minimums. Materials must be tested under actual service to determine their suitability for a particular purpose.



Aearo Technologies • a 3M company

www.earshockandvibe.com www.earsc.com
E-mail: solutions@earsc.com

Toll-free hotline
(877) EAR-IDEA
(327-4332)

7911 Zionsville Road

Indianapolis, IN 46268

Phone (317) 692-1111

Fax (317) 692-3111

650 Dawson Drive

Newark, DE 19713

Phone (302) 738-6800

Fax (302) 738-6811