

Product Name: Castle patch antenna with EVB - EVB+PB25D8

Part Number: H2BDAC1A2T0100

Features:

- Supporting (L1+L5) GPS/ BDS/Galileo/QZSS/IRNSS
- Stable and reliable in performances
- Low temperature coefficient of frequency
- RoHS 2.0 compliance

Applications:

- Automotive telematics
- Safety of life transportation
- Marine
- Navigation

Castle patch antenna with EVB

MODEL: EVB+PB25D8

Version: C

I. Patch Antenna Specifications:

Items	Specifications	
Navigation	GPS L1/ Galileo E1/ BDS B1/ QZSS L1	GPS L5 Galileo E5a/ BDS B2/ QZSS L5 IRNSS L5
Center Frequency (MHz)	1575.42	1176.5
Return loss (dB)	< -10 Typ.	
Peak Gain (dBi)	5 Typ.	3 Typ.
Axial Ratio (dB)	<3 Typ.	
Average Gain(dB)	-2.2 Typ.	-3.2 Typ.
Efficiency (%)	60 Typ.	48 Typ.
Impedance (Ω)	50	
Polarization	RHCP	

Environmental Conditions	
Operation Temperature (°C)	-40 ~ +85
Storage Temperature (°C)	-5 ~ +40
Relative Humidity	10 ~ 70 %

© Unictron Technologies Corp.
All specifications subject to change without notice.

II. Antenna Dimensions (unit: mm):

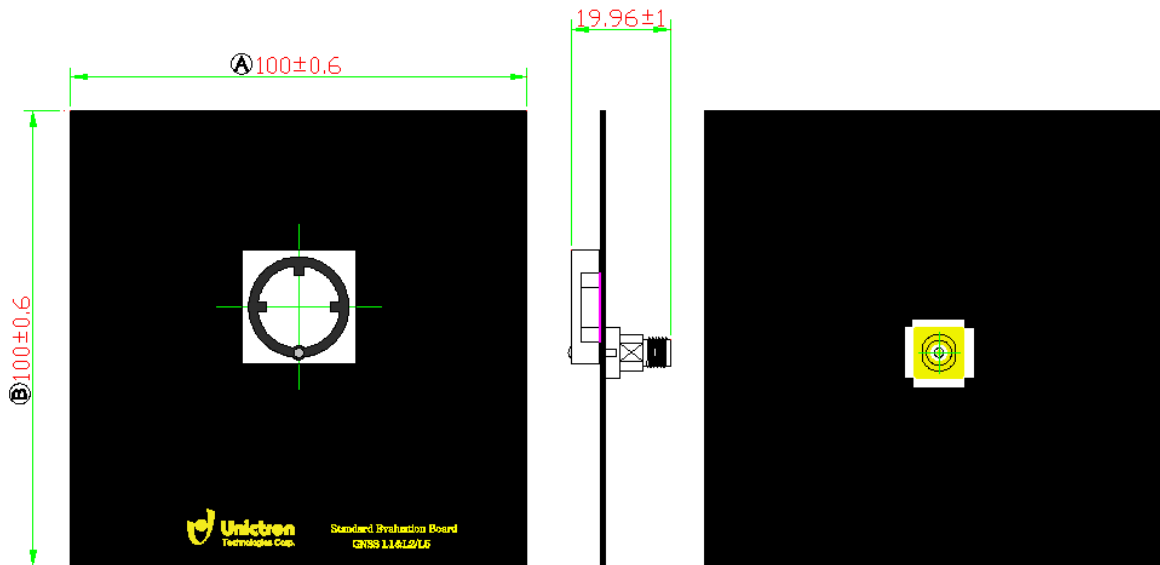

© Unictron Technologies Corp.
All specifications subject to change without notice.

NOTE:

1. All materials are RoHS 2.0 compliant.
2. "A~B" Critical Dimensions.
3. "()" Reference Dimensions.

III. Block Diagram

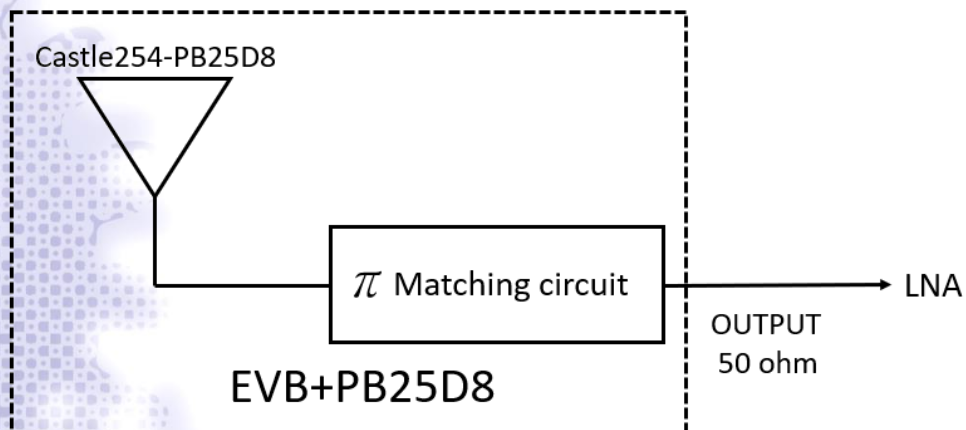

IV. Matching circuit

With the following recommended values of matching and tuning components, at our standard 100 x 100 mm² evaluation board. However, these are typical reference values which may need to be changed when circuit boards or part vendors are different.

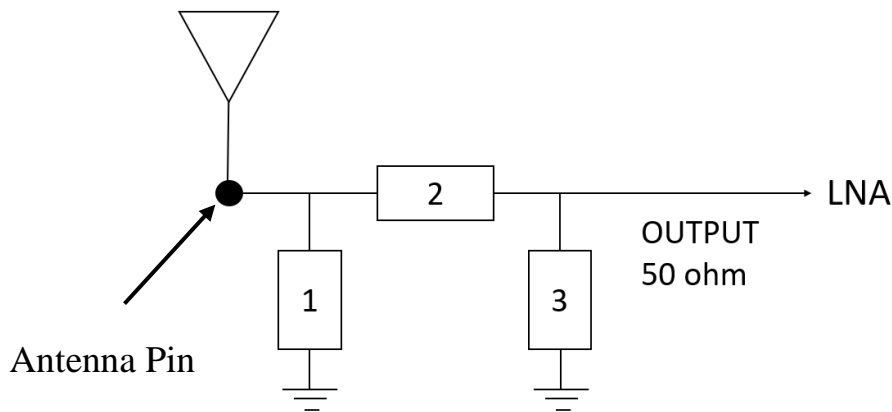
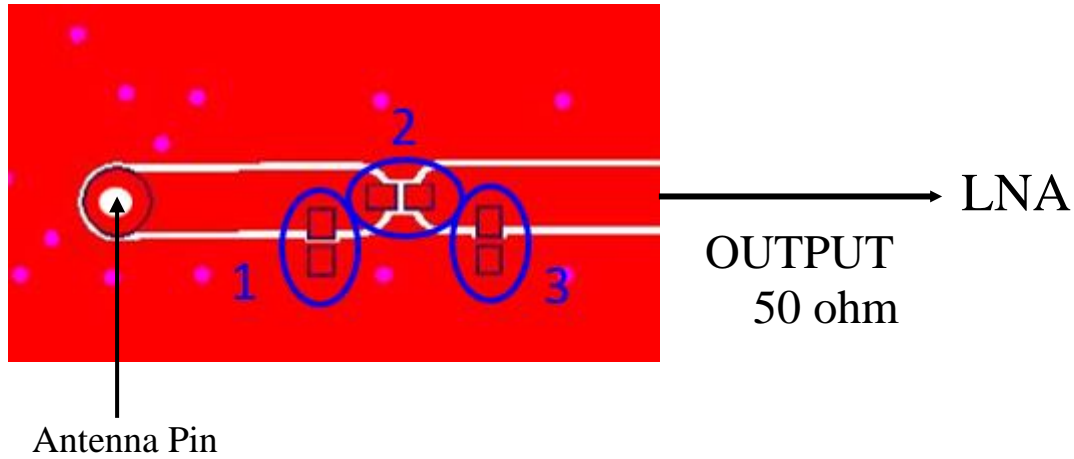

System Matching Circuit Component			
Location	Description	Vendor	Tolerance
1	4.7nH (0402)	MURATA	±0.1nH -
2	0Ω, (0402)	-	-
3	N/A	-	-

© Unictron Technologies Corp.
All specifications subject to change without notice.

V. Properties:

a) Return loss (dB)

I. GNSS L1 Band

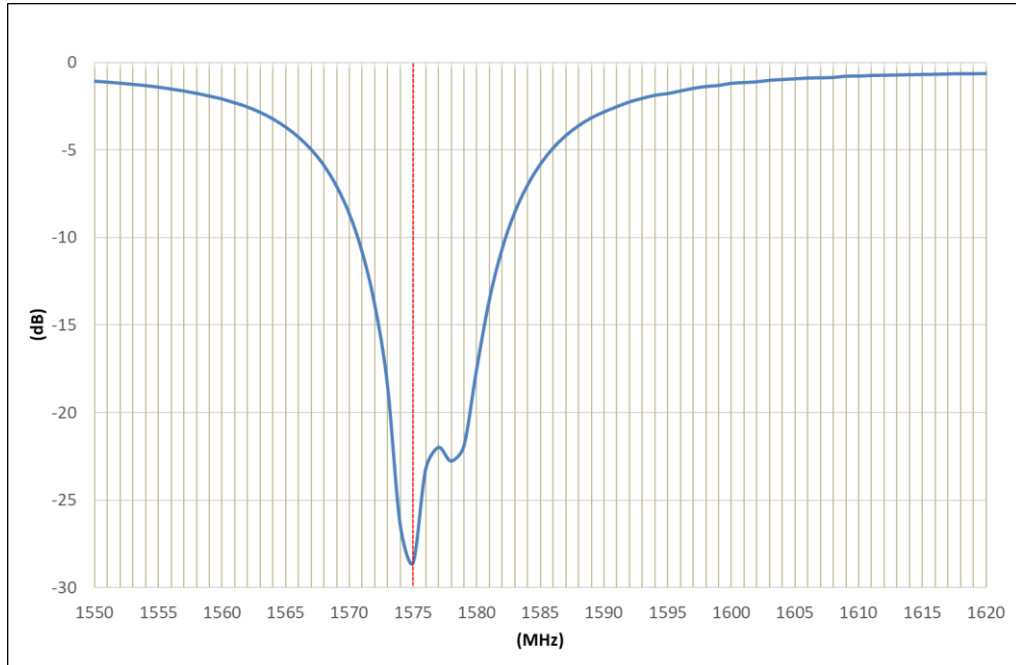

II. GNSS L5 Band

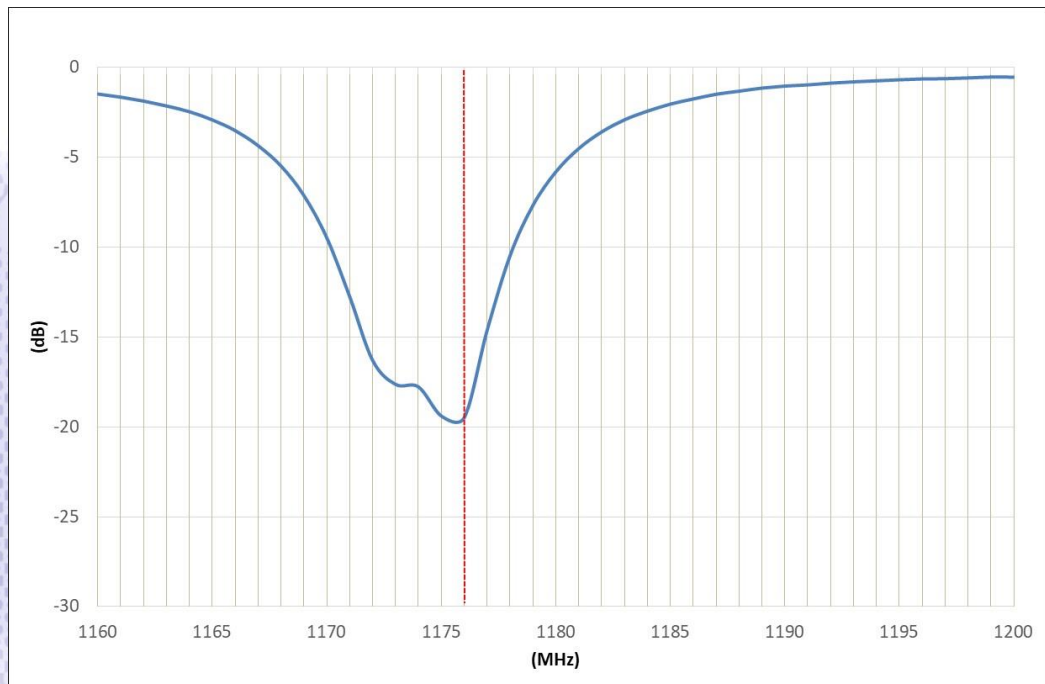

© Unictron Technologies Corp.
All specifications subject to change without notice.

b) Peak Gain (dBi)

I. GNSS L1 Band



II. GNSS L5 Band

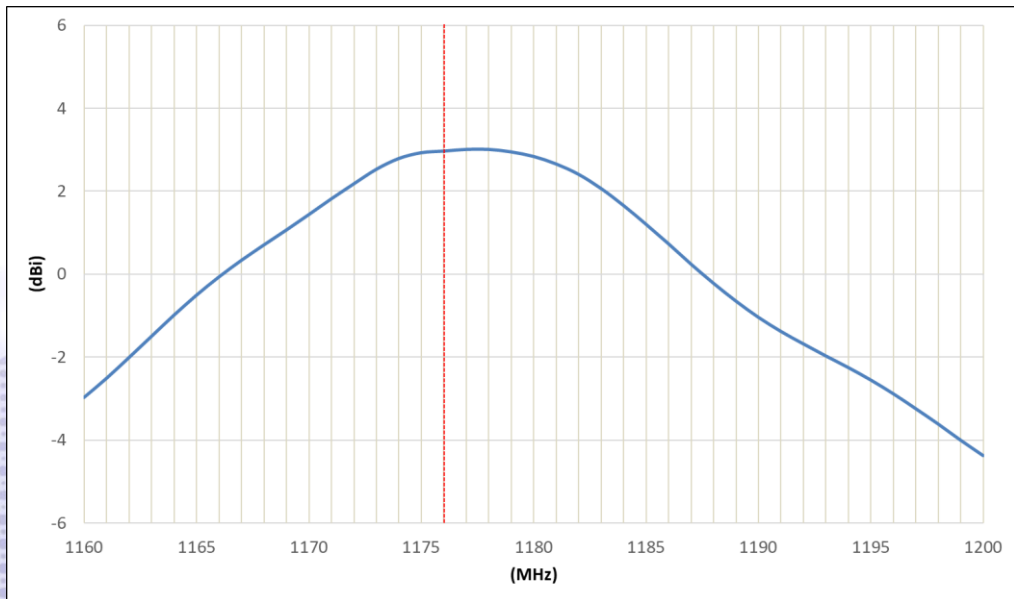

© Unictron Technologies Corp.
All specifications subject to change without notice.

c) Axial Ratio (dB)

I. GNSS L1 Band

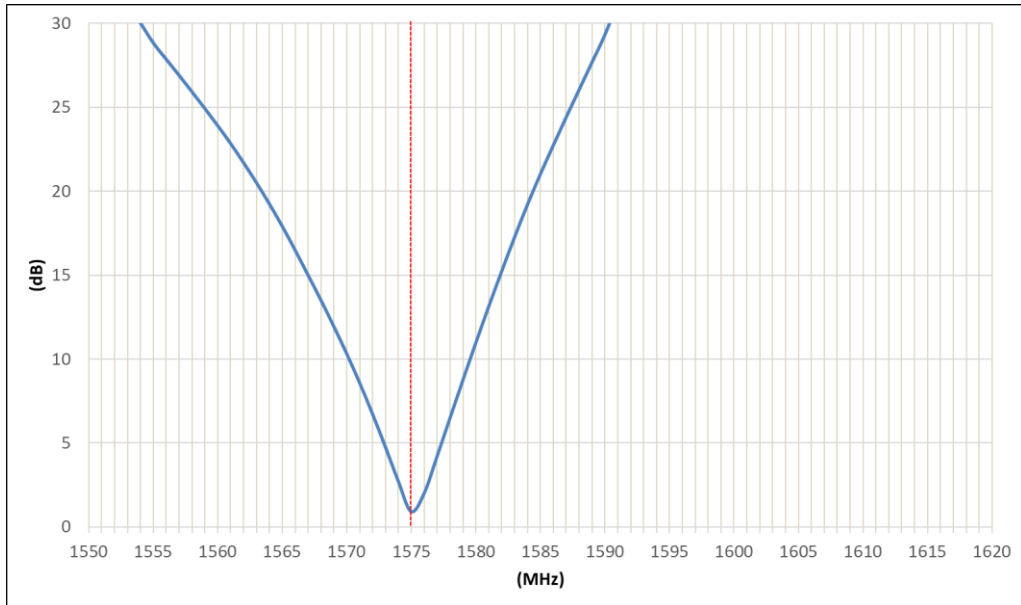

II. GNSS L5 Band

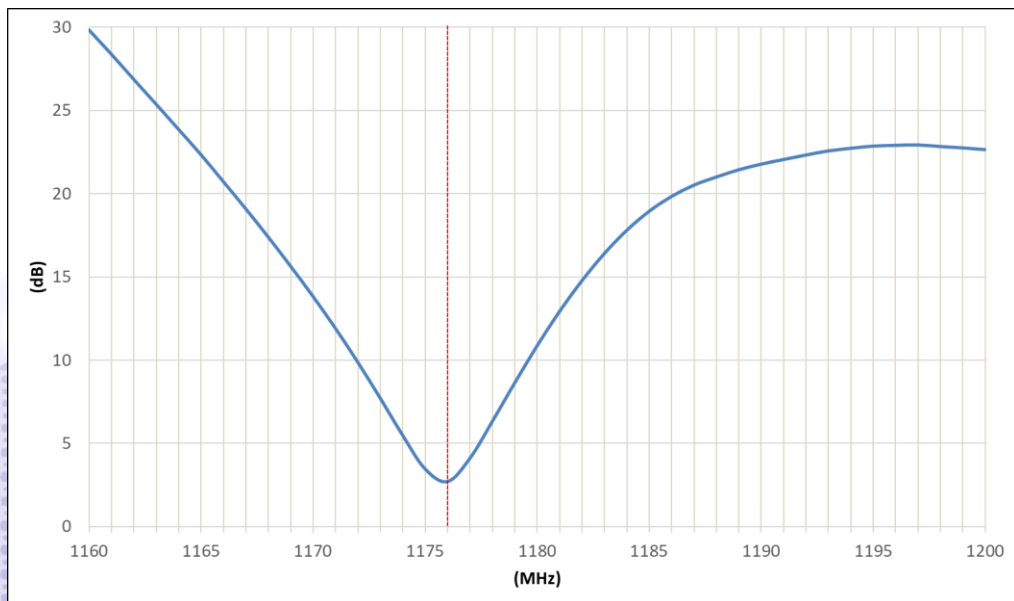

© Unictron Technologies Corp.
All specifications subject to change without notice.

d) Average Gain(dB)

I. GNSS L1 Band

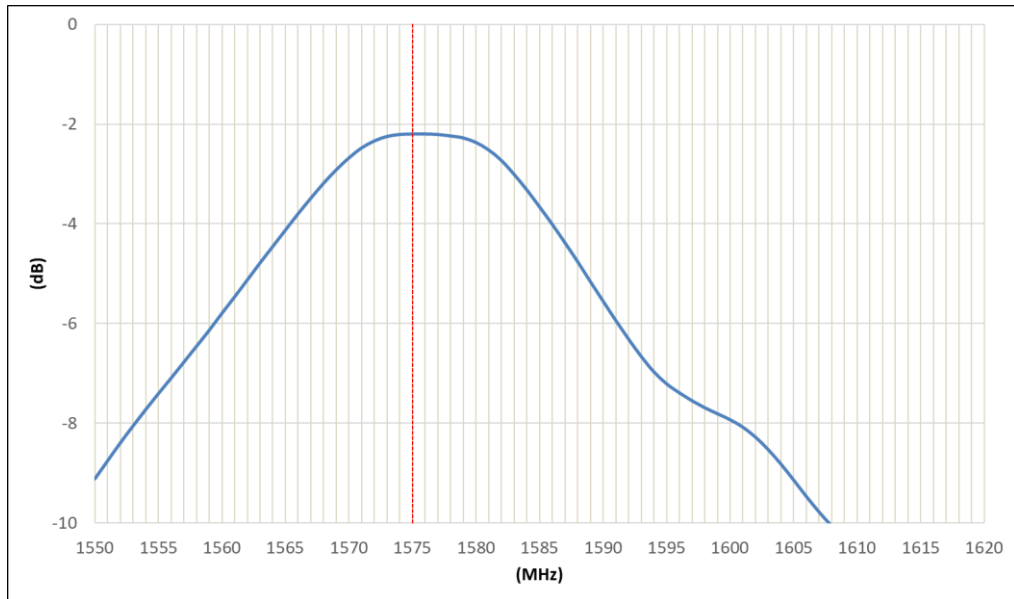

II. GNSS L5 Band

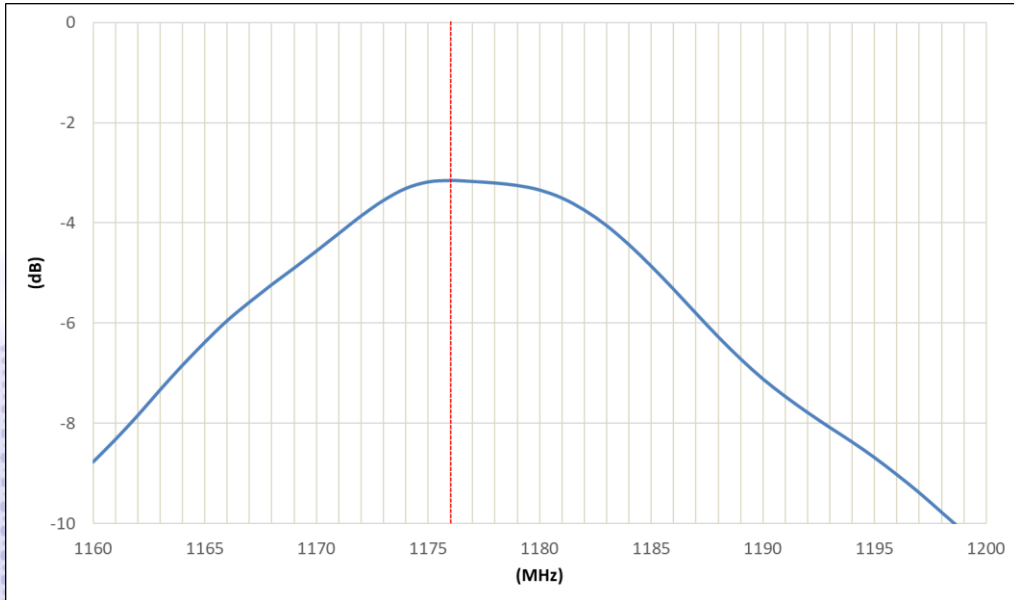

© Unictron Technologies Corp.
All specifications subject to change without notice.

e) Efficiency (%)

I. GNSS L1 Band

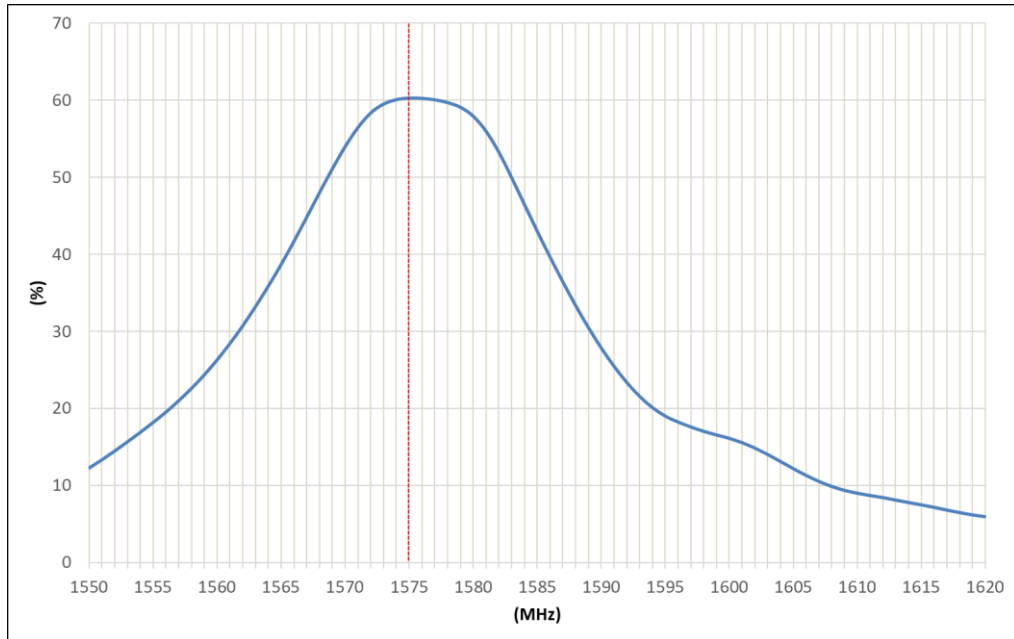

II. GNSS L5 Band

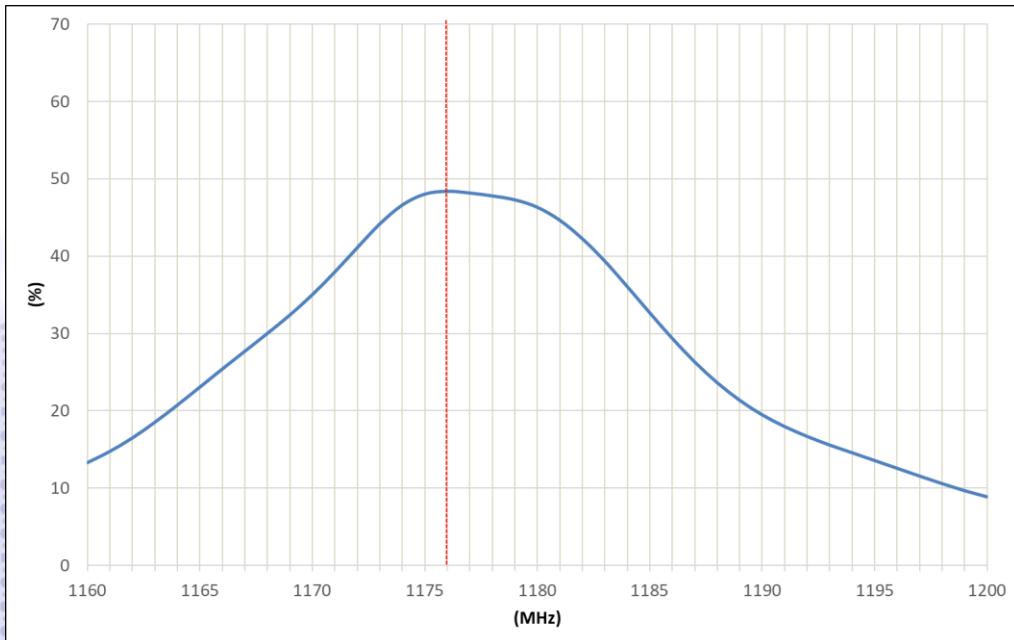

© Unictron Technologies Corp.
All specifications subject to change without notice.

VI. Antenna Radiation Pattern Measurement:

The antenna radiation patterns are measured in Unictron's 3D Anechoic Chamber. The measurement setup is as show below.

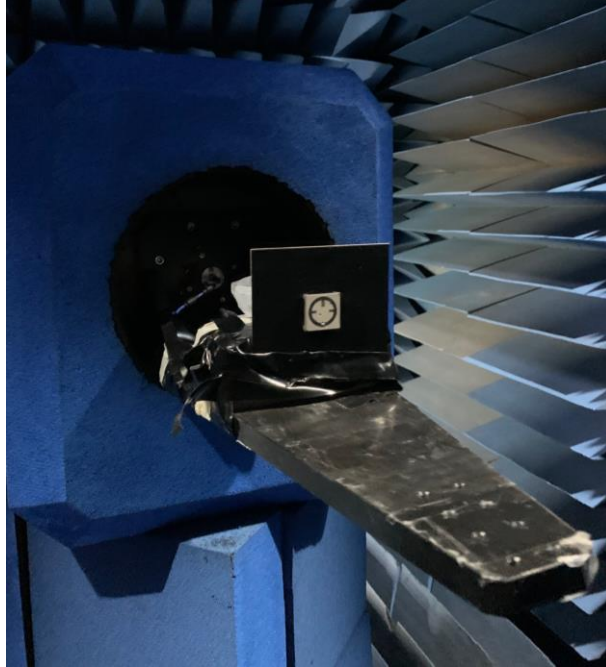

© Unictron Technologies Corp.
All specifications subject to change without notice.

2D Radiation Gain Pattern

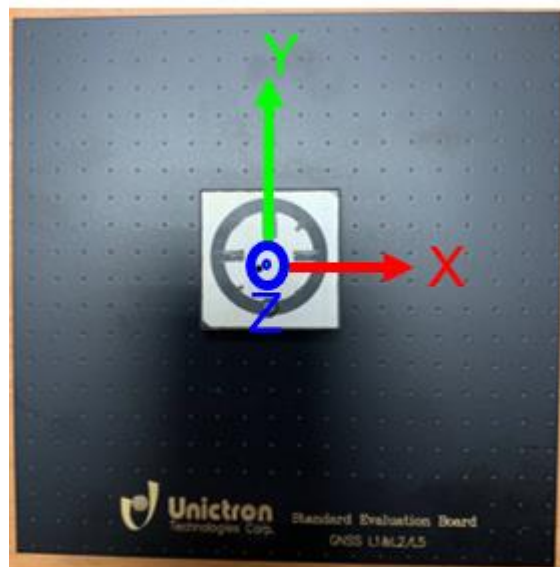

a) GNSS L1 Band @1575.42MHz (unit: dBi)

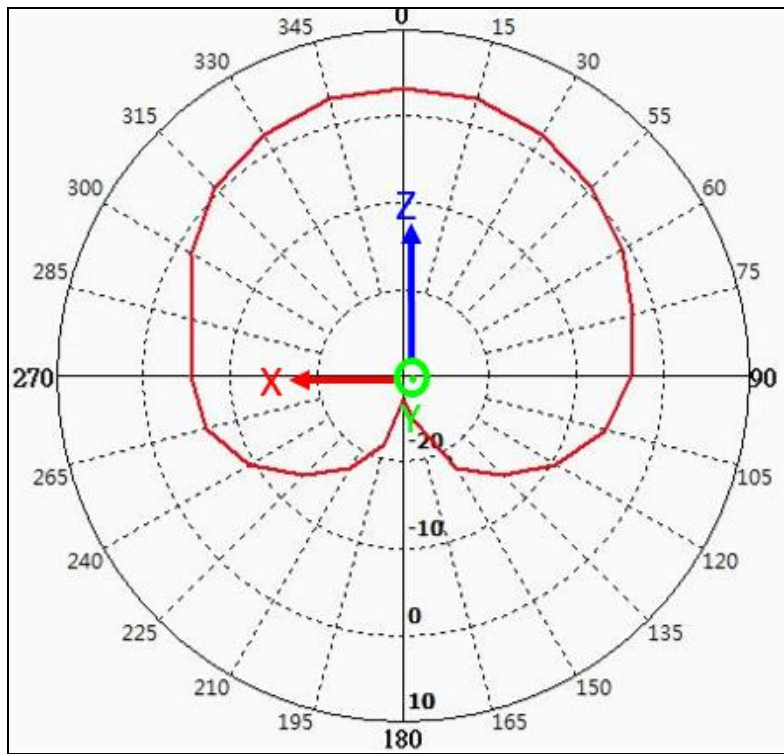

b) GNSS L5 Band @1176.5MHz (unit: dBi)

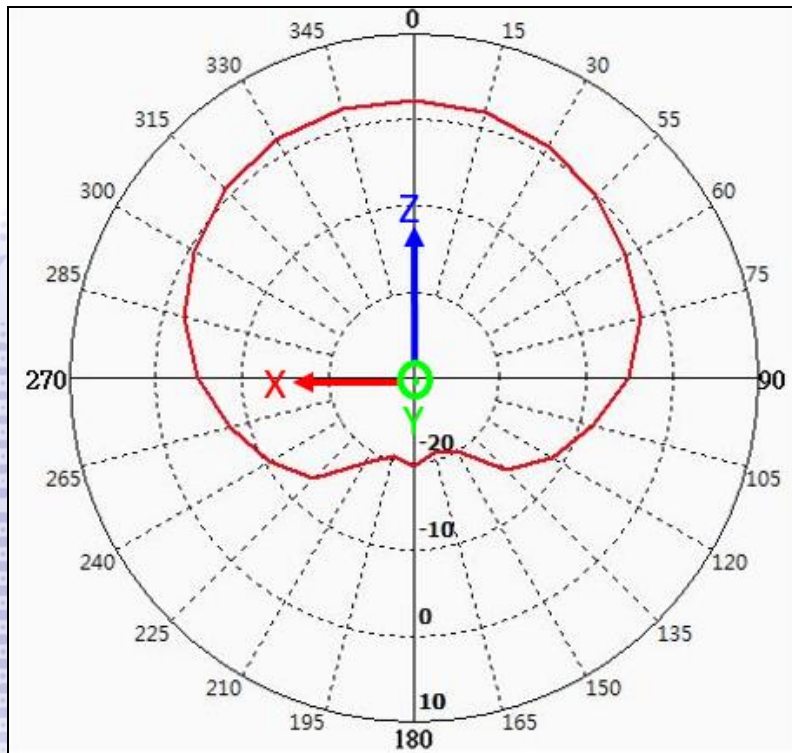





© Unictron Technologies Corp.
All specifications subject to change without notice.

VII. Packing

- a) Weight:
Unit Weight: 42 ± 5 (g)
- b) Quantity:
Each Pag : 1 pcs
Each outer carton : 50 pcs

© Unictron Technologies Corp.
All specifications subject to change without notice.

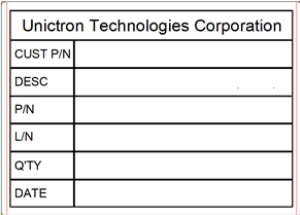
Step	Pictures	Descriptions
1		Place product into a double-layered antistatic bubble bag.
2		Place packaged product into a 1.3 cubic-foot carton.
3		Place 25 antistatic double layered bubble bag in an interlace pattern in each layer, with two layers per carton, total 50pcs per carton.
4	 	Seal the carton with packaging tape. Attach label to the top left corner on the side of the carton to complete packaging.