

# SPL16-005

## Digital pressure sensor

Pb-free, halogen-free and RoHS compliant

# Restricted

## 1. Security warning

The information contained in this document is the exclusive property of Goermicro Inc. and should not be disclosed to any third party without the written consent of Goermicro Inc.

## 2. Publication history

Version	Date	Description	Author	Approved
<b>preliminary</b>	2022.07.01	New design	Tina	Wiming
<b>preliminary</b>	2022.09.28	Update Absolute maximum ratings	Tina	Wiming
<b>preliminary</b>	2023.02.11	Update Pressure precision ,current consumption and absolute maximum ratings	Tina	Wiming
<b><i>preliminary</i></b>	2023.02.24	Add MSL and Reliability Specifications	Tina	Wiming

# Index of Contents

<b>1. Introduction</b>	<b>4</b>
<b>2. Test condition</b>	<b>5</b>
<b>3. Absolute maximum ratings</b>	<b>5</b>
<b>4. Electrical characteristics</b>	<b>5</b>
<b>5. Operation</b>	<b>6</b>
5.1 Operating Modes	6
5.2 Measurement Flow	8
5.3 Pressure Measurement	8
5.4 Temperature Measurement	9
5.5 Sensor Interface (I2C)	9
5.6 Interrupt	10
5.7 FIFO Operation	11
5.8 Calibration and Measurement Compensation	11
<i>i. How to Calculate Compensated Pressure Values</i>	12
<i>ii. How to Calculate Compensated Temperature Values</i>	12
<i>iii. How to Calculate Interrupt Pressure Value</i>	12
<b>6. Applications</b>	<b>13</b>
6.1 Calculating absolute altitude and calculating pressure at sea level	14
<b>7. Register Map</b>	<b>15</b>
7.1 Read-only registers	16
7.2 Write-only registers (command)	17
7.3 Read-Write registers	17
<b>8. Mechanical characteristics</b>	<b>19</b>
8.1 Pin configuration	19
8.2 Outline dimensions	20
<b>9. Storage and transportation</b>	<b>21</b>
<b>10. Soldering recommendation</b>	<b>21</b>
<b>11. Package specifications</b>	<b>22</b>
<b>12. Reliability Specifications</b>	<b>24</b>

## 1. Introduction

The SPL16-005 is a miniaturized Digital Barometric Air Pressure Sensor with a high accuracy and a low current consumption. The SPL16-005 is both a pressure and a temperature sensor. The pressure sensor element is based on a capacitive sensing principle which guarantees a high precision during temperature changes. The small package makes the SPL16-005 ideal for mobile applications and wearable devices.

The SPL16-005's internal signal processor converts the output from the pressure and temperature sensor elements to 24-bit results. Each pressure sensor has been calibrated individually and contains calibration coefficients. The coefficients are used in the application to convert the measurement results to true pressure and temperature values.

The SPL16-005 has a FIFO that can store the latest 32 measurements. By using the FIFO, the host processor can remain in a sleep mode for a longer period of time between readouts. This can reduce the overall system power consumption.

### Key features

- Absolute Pressure range: 30 ... 700kpa
- Temperature Range: 0...+60°C
- Supply voltage: 1.7 ... 3.6V (VDD)
- Absolute accuracy: typ.±0.1Kpa (90~110kpa)
- Temperature accuracy: typ. ± 1°C (0~60°C)
- Measurement time: typ. 4 ms
- Average current consumption: <5 µA, Standby current: <100nA
- I2C, Embedded 24-bit ADC
- Pb-free, halogen-free and RoHS compliant

### Typical applications

- Wearable devices
- Altimeter and barometer for portable devices
- Enhancement of GPS navigation (dead-reckoning, slope detection, etc.)
- In- and out-door navigation
- Weather station equipment
- e-cigarettes
- Approximately 60m water-depth measurement

### Specific notes

Particles can influence the performance of the pressure sensor, we strongly recommend you to introduce special measures to avoid deposition of particles on the MEMS membrane or screen particles after assembly as the assembly process is considered to be the main root cause for particle generation.

## 2. Test condition

**Table 1: Test condition**

Standard Conditions	Temperature	Humidity	Pressure
Environment conditions	-40°C...+85°C	25%RH...75%RH	300hPa...7000hPa
Basic test conditions	+25°C	60%RH...70%RH	300hPa...7000hPa

## 3. Absolute maximum ratings

**Table 2: Absolute maximum ratings**

Parameter	Condition	Min	Max	Units
Storage temperature		-40	+125	°C
Supply Voltage	All pins	-0.3	+3.63	V
Voltage at all IO Pins	All pins	-0.3	VDD+0.3	V
ESD rating	JESD22-A114	-2	+2	kV
P <sub>water</sub> Overpressure			1	MPa
<b>MSL</b>	<b>MSL 3</b>			

## 4. Electrical characteristics

VDD = 1.8V, T=25°C, unless otherwise noted. If not stated otherwise, the given values are  $\pm 3$ -Sigma values over temperature/voltage range in the given operation mode.

**Table 3: Operating conditions, output signal and mechanical characteristics**

Parameter	Symbol	Condition	Min	Typ. <sup>(1)</sup>	Max	Units
Operating Temperature	TA	Operational	-40	25	85	°C
		Full accuracy	0	25	60	°C
Operating Pressure	P		30		700	kpa
Supply voltage	VDD		1.7		3.6	V
Supply current	I <sub>dd</sub>	1Hz (with 1 measurement per second.)			5	uA
Peak current	I <sub>peak</sub>	During conversion		0.9	1.15	mA
Standby current	I <sub>ddsbm</sub>			5	100	nA
Relative accuracy pressure	P <sub>R</sub>	90~100Kpa		±0.1		hPa

Absolute accuracy pressure	P_A	30~110Kpa 0...+60°C		±1		hPa
		110~400Kpa 0...+60°C		±15		hPa
		400~700Kpa 0...+60°C		±100		hPa
Noise in pressure	P_Noise	Low power		12		PaRMS
		High precision		4.5		PaRMS
Absolute accuracy temperature		0~+60°C		±1		°C
Pressure/Temperature measurement rate	f		0.25		128	Hz
Pressure measurement time	t			4		ms
Serial data clock	f <sub>I2C</sub>	For I2C			3.4	MHz
Solder drift		100Kpa@25°C		2		hPa

Note: (1) Typical specifications are not guaranteed;

## 5. Operation

### 5.1 Operating Modes

The SPL16-005 supports the following operation condition modes. User can have the highest flexibility from selecting a high number of possible combinations of the chip settings, such as output data rate, with these operation modes.

Three operation mode:

- Standby mode
- Oneshot mode
- FIFO stream mode

In standby mode, this is the default mode after power on. No measurements are performed. All registers values can be accessible.

Oneshot mode, it is a single measurement. When this mode is enabled, one pressure measurement is performed after one temperature measurement according to the selected precision and it will return to the

standby mode after the measurement is finished. If a next measurement is needed, the oneshot mode must be selected again. This is suitable for low sampling rate required application or host-based synchronization.

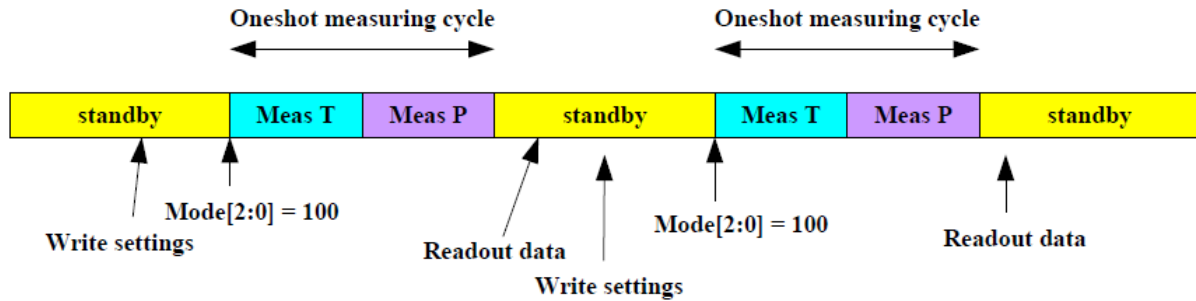

Figure 1: Oneshot mode

FIFO stream mode, SPL16-005 has a set of FIFO registers able to store 32 bridge sensor measurement values. It helps to improve the system power saving, because the host processor only needs to wake up SPL16-005 when it requested and bursts the data reading out from the FIFO without continuously polling data from SPL16-005. In FIFO stream mode, the measurement is also performed cyclic continuously and it stops to fill FIFO registers until it is full with 32 bridge sensor measurement values. Once the FIFO data is being readout and the FIFO registers become not full, the measurement will continuously fill data into FIFO again and stop till FIFO full. The output values in the FIFO will not be discarded until it is being readout. When FIFO is from full to not full condition, the older values in the FIFO are discarded and their location will be filled with new bridge sensor measurement values. This kind of operation has the advantage that host processor no needs to re-enable the FIFO stream mode again when FIFO data are readout after FIFO full. The data can be continuously readout if FIFO buffer is not full and has data in it.

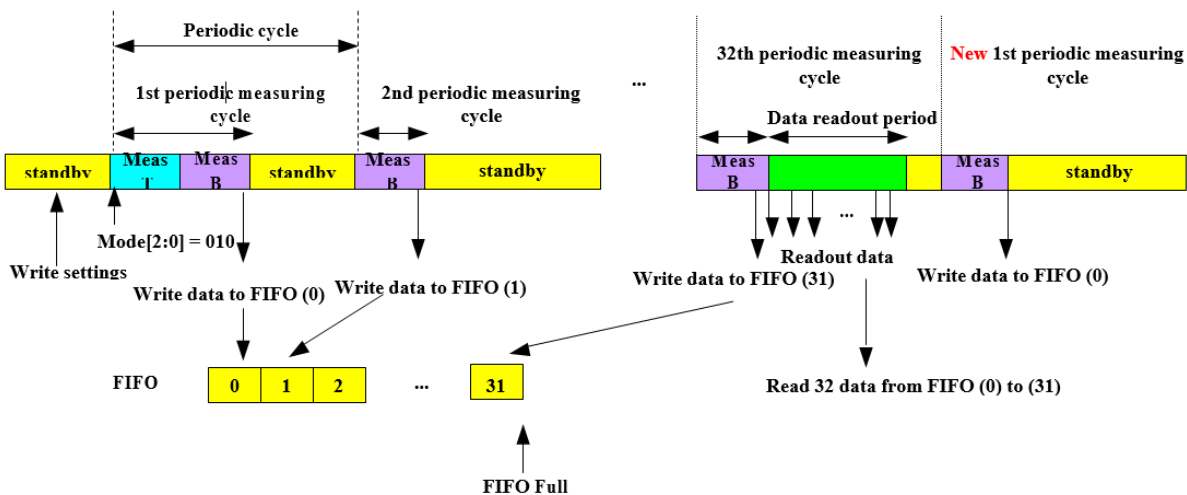

Figure 2: FIFO stream mode

## 5.2 Measurement Flow

When SPL16-005 is enabled to measure data, it will start to perform temperature and pressure or only pressure measurement. An interrupt can be generated or the status flags will be shown in the registers if readout data is ready. After measurement finished, SPL16-005 can enter into standby mode by itself or by host informing a sleep mode command.

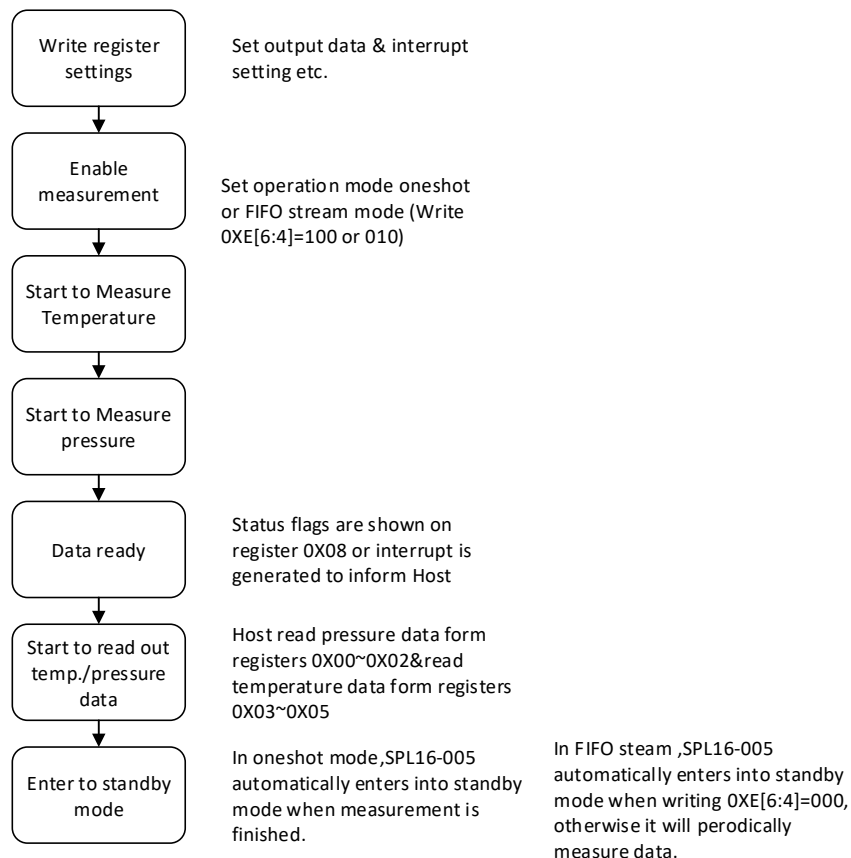

Figure 3: Measurement flow

## 5.3 Pressure Measurement

Pressure measurement is always enabled when SPL16-005 is enabled to measure data. When enabled, the pressure output data rate can be chosen from 0.25 to 128Hz by setting [7:4] bits of output data rate control register (0x0F).

Table 4: Output data rate control register (0x0F)

[7:4]	Output data rate of pressure data
0010	128 Hz
0011	64 Hz
0100	32 Hz



0101	16 Hz
0110	8 Hz
0111	4 Hz
1000	2 Hz
1001	1 Hz
1010	0.5Hz
1011	0.25Hz

## 5.4 Temperature Measurement

When setting bit [3] of output data rate control register (0x0F) to be “1”, the temperature measurement can be skipped otherwise it is enabled. When enabled, the output data rate of temperature data is not directly controlled by register bit setting. The bits [3:0] of register 0x0F define the pressure to temperature ratio. It is to be used with the output data rate of pressure data in bits [7:4] of register 0x0F to have the output data rate for temperature data. For example, when output data rate of pressure data is chosen as 8Hz, while P/T ratio is selected as 8. That means the output data rate of temperature is 1Hz.

**Table 5: Output data rate control register (0x0F)**

[3:0]	P/T ratio
0000	1
0001	2
0010	4
0011	8
0100	16
0101	32
0110	64
1xxx	No temperature

## 5.5 Sensor Interface (I2C)

I2C supports standard ( $\leq 100\text{KHz}$ ), fast ( $\leq 400\text{KHz}$ ) and high speed ( $\leq 3.4\text{MHz}$ ) modes. The digital interface supports 3 kinds of transactions:

- Single byte write
- Single byte read
- Multiple byte read (single register address and multiple data read with auto-incremented address)

SDO should be connected to VDD, the address is 1110001(0x71). This SDO pin should not be left floating, it will make I2C device address undefined.

**- I2C write**

When master sends I2C with RW bit (bit 0 of I2C device address byte) equal to '0', I2C is in writing operation. Then master sends pairs of register address and register data to SPL16-005. The transaction will be end if a stop condition is sent by master.

Single byte write is depicted in figure, multiple bytes write is not address auto-incremented

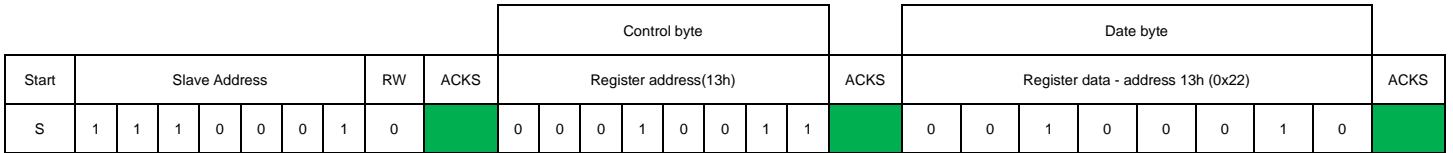

**- I2C read**

SPL16-005 supports register address auto-incremented. When master sends the first register address to SPL16-005, SPL16-005 will output sequential data until a no-ack and stop condition occurs. The transaction is depicted in the figure.



**5.6 Interrupt**

- SPL16-005 can generate an interrupt when the corresponding event is triggered. The interrupt trigger source is pressure data ready, pressure data larger/lower than predefined threshold, FIFO over half or FIFO full when FIFO mode enabled (note 1). SPL16-005 uses the SDO pin for the interrupt signal. The output type have been configured the as open-drain, and interrupt polarity is active low.
- When I2C interface is selected, the SDO pin serves as a multifunctional pin at the same time. It acts as an input pin and the least significant bit of SPL16-005 I2C device address when I2C read/write is operated. It acts as an output pin when interrupt is enabled and I2C read/write is not processing.
- The interrupt will be cleared when a read of status register 0x08h is performed.

(Note 1: refer to interrupt control register (0x0Dh))

## 5.7 FIFO Operation

The SPL16-005 FIFO can store the last 32 measurements of pressure or temperature. This reduces the overall system power consumption when the host processor does not need to continuously pull data from the sensor but can go into standby mode for longer periods of time.

- The FIFO can be enabled in the register 0x0E register.
- The FIFO will store any combination of temperature and pressure measurements since the measurement rate of temperature and pressure can be configured in the register 0x0F.
- The register 0x00~0x02 will contain the FIFO pressure and/or temperature results, if the FIFO is enabled. The measurement type can be seen in the result data. The sensor will set the least significant bit to:

'1' if the result is a temperature measurement.

'0' if it is a pressure measurement.

The sensor uses 24 bits (reg. 0x00~0x02) to store the measurement result. Because this is more bits than is needed to cover the full dynamic range of the pressure sensor, using the least significant bit to label the measurement type will not affect the precision of the result.

- The multiple bytes read mode is required to guarantee the new FIFO data can be correctly updated to register 0x00~0x02. When reading FIFO data using the multiple bytes read mode, the register address will automatically increase and it will automatically return to 0x00 when it reaches 0x02.
- When a measurement has been read out, the FIFO will auto increment and place the next result in the data register. A flag will be set in the register 0x08 when the FIFO is empty. When the FIFO is empty and all following reads will return the last read data.
- If the FIFO runs full, a flag will be set in the register 0x08 and the sensor will generate an interrupt if this has been enabled in the register 0x0D.
- The number of data stored in the FIFO can be obtained by checking the register 0x0A.
- FIFO only contains pressure value by default. By configuring bit7 of the register 0x0D, FIFO will contain both pressure and temperature values.

## 5.8 Calibration and Measurement Compensation

The SPL16-005 is a calibrated sensor. These are used in the application (for instance by the host processor) to compensate the measurement results for sensor non-linearity's.

The sections that follow, describe how to calculate the compensated results and convert them into kpa and °C values.

## i. How to Calculate Compensated Pressure Values

1. Read the pressure result from the registers (0x00~0x02).
2. Convert to decimal P<sub>raw</sub>.
3. Calculate pressure value P (kpa)

$$P_{(kPa)} = \frac{P_{raw}}{2^{24}} * 800$$

## ii. How to Calculate Compensated Temperature Values

1. Read the temperature result from the registers (0x03~0x05).
2. Convert to decimal T<sub>raw</sub>.
3. Calculate temperature value T (°C)

$$T_{(°C)} = \frac{T_{raw}}{2^{24}} * 125 - 40$$

## iii. How to Calculate Interrupt Pressure Value

1. Calculate interrupt pressure value raw data P<sub>raw</sub>

$$P_{(raw)} = \frac{P_{(kPa)}}{800} * 2^{22}$$

2. Convert to Binary P<sub>raw</sub>.
3. Write P<sub>raw</sub> to 0x19~0x1B (Upper threshold) or 0x1C~0x1E (Lower threshold)

## 6. Applications

The example application circuit example uses the I2C serial interface with interrupt.

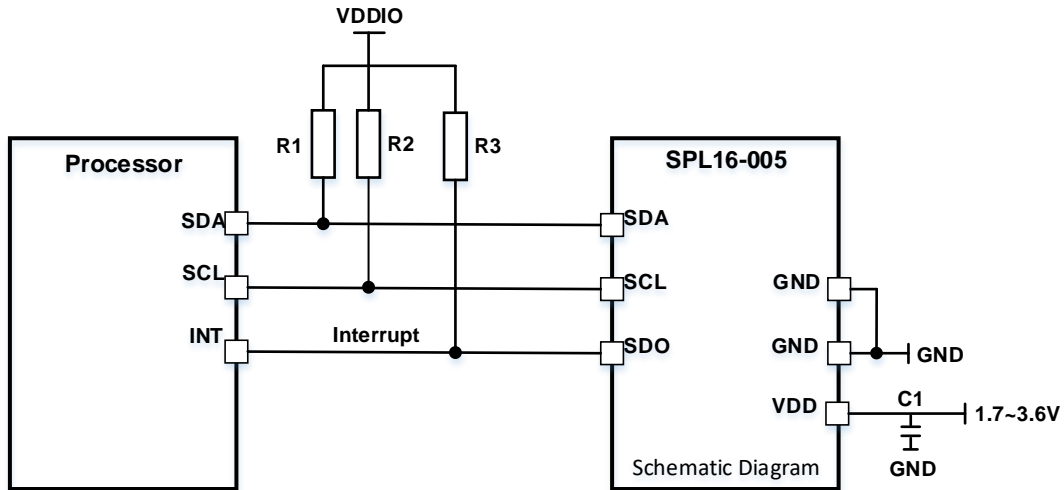

Figure 4: Typical application circuit

Table 6 Component Values

Component	Symbol	Values			Unit	Note / Test Condition
		Min.	Typ.	Max.		
Pull-up/down Resistor	R1, R2		4.7	10	KΩ	
	R3		3.3	10	KΩ	
Supply Blocking Capacitor	C1	100	100		nF	The blocking capacitors should be placed as close to the pins as possible.

### 6.1 Calculating absolute altitude and calculating pressure at sea level

With the measured pressure  $P$  and the pressure at sea level  $P_0=1013.25\text{hPa}$ , the altitude in meters can be calculated with the international barometric formula:

$$\text{Altitude} = 44330 \times \left[ 1 - \left( \frac{P}{P_0} \right)^{\frac{1}{5.255}} \right]$$

Thus, a pressure change of  $\Delta p = 1\text{hPa}$  corresponds to 8.43m at sea level.

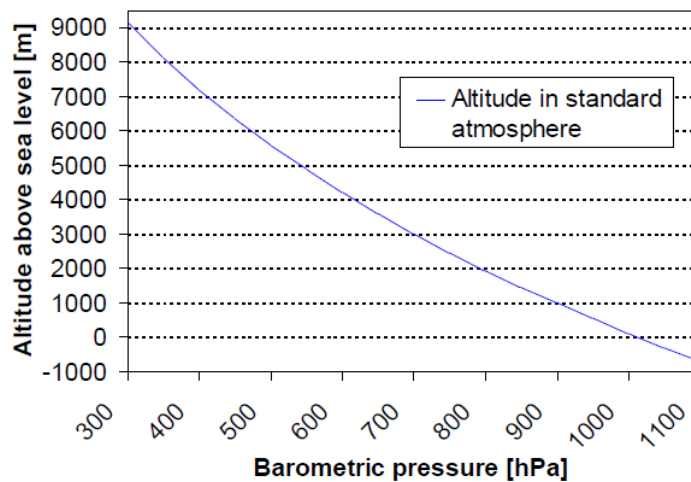

**Figure 5: Transfer function: Altitude over sea level – Barometric pressure**

With the measured pressure  $p$  and the absolute altitude the pressure at sea level can be calculated:

$$P_0 = \frac{p}{\left( 1 - \frac{\text{altitude}}{44330} \right)^{5.255}}$$

Thus, a difference in altitude of  $\Delta\text{altitude} = 10\text{m}$  corresponds to 1.2hPa pressure change at sea level.

## 7. Register Map

**Table 7 Register Map**

Byte	Name	Description	Type	B7	B6	B5	B4	B3	B2	B1	B0	Default	
00H	PSR2	Pressure data reading MSB	R	PSR[23:16]								00H	
01H	PSR1	Pressure data reading LSB	R	PSR[15:8]								00H	
02H	PSR0	Pressure data reading XLSB	R	PSR[7:0]								00H	
03H	TMR2	Temperature data reading MSB	R	TMR[23:16]								00H	
04H	TMR1	Temperature data reading LSB	R	TMR[15:8]								00H	
05H	TMR0	Temperature data reading XLSB	R	TMR[7:0]								00H	
08H	STAX	Chip status flag	R	STA[7:0]								00H	
09H	IDX	Chip ID and revision ID	R	CID[3:0]				RID[3:0]				14H	
0AH	FIFOX	FIFO status	R					FIFO[4:0]					
0DH	INTX	Interrupt control	RW	INT[7:0]								00H	
0EH	MODX	Mode control	RW	MOD[3:0]								NR	00H
0FH	ODRX	Output data rate control	RW	PODR[3:0]				PTR[3:0]				90H	
19H	USH2	Upper threshold MSB	RW	USH[23:16]								20H	
1AH	USH1	Upper threshold LSB	RW	USH[15:8]								00H	
1BH	USH0	Upper threshold XLSB	RW	USH[7:0]								00H	
1CH	LSH2	Lower threshold MSB	RW	LSH[23:16]								00H	
1DH	LSH1	Lower threshold LSB	RW	LSH[15:8]								01H	
1EH	LSH0	Lower threshold XLSB	RW	LSH[7:0]								00H	

## 7.1 Read-only registers

### [Output data]

The pressure sensor and temperature sensor data reading is 24bit unsigned values, ranging from 0 to FF-FF-FFH. If the FIFO is enabled, the register will contain the FIFO pressure and/or temperature results. Otherwise, the register contains the pressure measurement results and will not be cleared after read.

**Table 8: Data output reading registers**

Byte	Bit	Name	Type	Description	Default
00H,01H,02H		PSR	R	Pressure data reading	00-00-00H
03H,04H,05H		TMR	R	Temperature data reading	00-00-00H

### [Configurations]

**Table 9: Chip configuration registers**

Byte	Bit	Name	Type	Description	Default
08H	[7:0]	STA [7] [6] [5] [4] [3] [2] [1] [0]	R	Status flag indicator: Booting flag: 0: Booting now;           1: Boot process done FIFO empty: 0: FIFO has data;        1: FIFO is empty FIFO full: 0: FIFO is not full;     1: FIFO is full FIFO half: 0: FIFO <16;            1: FIFO >16 Reserved Over threshold: 0: Data in-bound;        1: Data > threshold; Under threshold: 0: Data in-bound;        1: Data < threshold; Data ready: 0: Measuring;            1: Data ready	00H
09H	[7:0]	/	R	Revision ID	14H
0AH	[4:0]	FIFO [4:0]		FIFO content: 00H: FIFO is empty    1FH: FIFO is full	00H

\*The status bits of register 0x08h will be cleared when a read of status register 0x08h is performed.



## 7.2 Write-only registers (command)

[Software reset]

**Table 10: Software reset**

Byte	Bit	Name	Type	Description	Default
0CH	[7:0]	RST[7:0]	W	Software reset for whole chip: '10100101': Reset whole chip 'XXXXXXX1': Reset FIFO	00H

## 7.3 Read-Write registers

[Interrupt control]

**Table 11: Interrupt control**

Byte	Bit	Name	Type	Description	Default
0DH	[7]	INT [7]	RW	Interrupt control: If FIFO contains temperature value. 0: No temperature value is stored in FIFO; 1: Pressure and temperature are both stored in FIFO	00H
	[6]			Reserved	
	[5]			If FIFO full:           0: Do not act;       1: Generate INT;	
	[4]			If FIFO over half:   0: Do not act;       1: Generate INT;	
	[3]			Reserved	
	[2]			If data> threshold:  0:Do not act;       1: Generate INT;	
	[1]			If data< threshold:  0: Do not act;       1: Generate INT;	
	[0]			If data is ready:     0: Do not act;       1: Generate INT;	

(\*Interrupt will not really output to SDO pin if the interrupt is not enabled in OTP memory.)

(\*The interrupt will be cleared when a read of status register 0x08h is performed.)

[System control]

**Table 12: System control**

Byte	Bit	Name	Type	Description	Default
0EH	[7]	ROW	RW	Output row data: 0= Calibrated data	0

				1= Get row data;	
0EH	[6:4]	MOD[2:0]	RW	Operation mode: 000: Sleep mode 001: / 010: FIFO 011: / 100: One shot 101: / 110: / 111: /	000
0EH	[3:0]	(Reserved)	RW		0000
0FH	[7:4]	PODR[3:0]	RW	Output data rate of pressure sensor: 0010:128 Hz 0011:64 Hz 0100:32 Hz 0101:16 Hz 0110:8 Hz 0111:4 Hz 1000:2 Hz 1001:1 Hz 1010:0.5Hz 1011:0.25Hz	1001
0FH	[3:0]	PTR[3:0]	RW	Output data rate ratio between (P/T): bit[3] is reserved 0000: 1 0100: 16 0001: 2 0101: 32 0010: 4 0110: 64 0011: 8 1xxx: No temperature	0000
13H	[7:4]	POSR[3:0]	RW	Over sampling rate of bridge sensor: (table 4-13, type A)	0010
13H	[3:0]	TOSR[3:0]	RW	Over sampling rate of temperature sensor: (table 4-13, type A)	0010
19H~1BH	[7:0]	USH	RW	Upper threshold	20-00-00H
1CH~1EH	[7:0]	LSH	RW	Lower threshold	00-01-00H

Table 13 Pressure precision (PaRMS)

Oversampling (POSR[3:0])	Single (0010)	2times (0011)	4times (0100)	8times (0101)	16times (0110)	32times (0111)	64times (1000)
Precision(PaRMS)	9.8	8.5	6.9	5.5	4.5	4.0	3.9

Table 14 Estimated current consumption (uA)

Oversampling (POSR[3:0])	Single (0010)	2times (0011)	4times (0100)	8times (0101)	16times (0110)	32times (0111)	64times (1000)
Measurements pr sec.(PODR[3:0])							
1 (1001)	3.0	3.4	4.2	5.6	8.4	14.1	25.3
2 (1000)	5.9	6.6	8.0	10.8	16.4	27.7	50.2
4 (0111)	11.4	12.8	15.6	21.3	32.5	55.1	/
8 (0110)	22.5	25.3	31.0	42.2	64.8	/	/
16 (0101)	45.7	50.3	61.6	84.1	/	/	/
32 (0100)	90.3	102.9	124.3	/	/	/	/
64 (0011)	180.3	201.6	/	/	/	/	/
128 (111)	365.8	/	/	/	/	/	/

## 8. Mechanical characteristics

### 8.1 Pin configuration

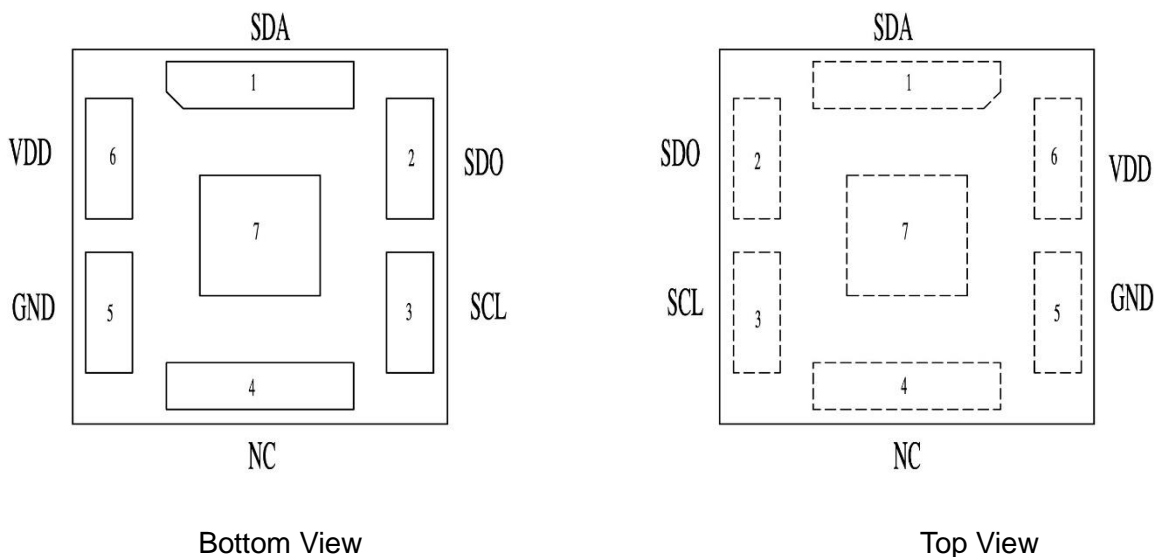

Figure 6: Layout pin configuration SPL16-005

**Table 15: Pin configuration of SPL16-005**

Pin	Name	I <sup>2</sup> C	I <sup>2</sup> C with interrupt
1	SDA	Serial data in/out	
2	SDO	Least significant bit in the device address	Interrupt pin and least significant bit in the device address
3	SCL	Serial Clock	
4	NC	Not connected	
5	GND	Ground	
6	VDD	Power Supply	
7	GND	Ground	

## 8.2 Outline dimensions

The sensor is a 7-pin metal housing LGA 2.80 (±0.15) × 2.80 (±0.15) × 1.95 (±0.15) mm<sup>3</sup> package. Its dimensions are depicted in Figure 2.

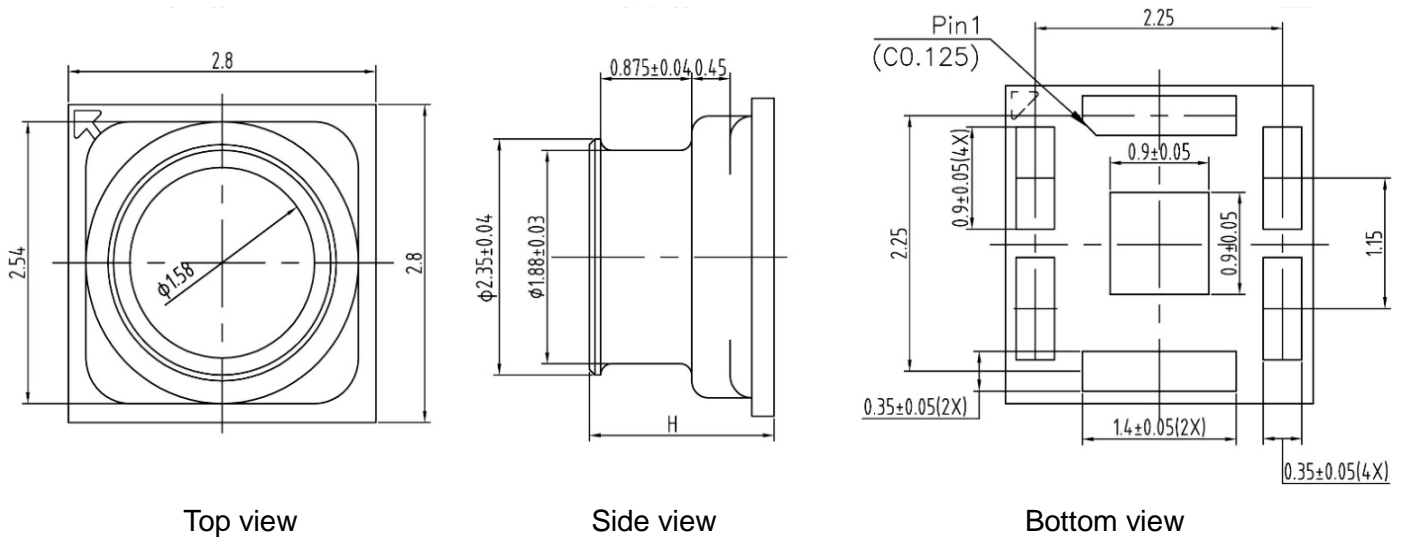

**Figure 7: SPL16-005 outline and mechanical data**

Note: General tolerances are ±0.05mm.

Item	DIMENSION (mm)	TOLERANCE(mm)
High(H)	1.95	±0.15
Width(W)	2.8	±0.15

## 9. Storage and transportation

- Keep in warehouse with less than 75% humidity and without sudden temperature change, acid air, any other harmful air or strong magnetic field.
- The MEMS pressure sensor with normal pack can be transported by ordinary conveyances. Please protect products against moist, shock, sunburn and pressure during transportation.
- Storage Temperature Range:  $-40^{\circ}\text{C}\sim+125^{\circ}\text{C}$
- Operating Temperature Range:  $-40^{\circ}\text{C}\sim+85^{\circ}\text{C}$

## 10. Soldering recommendation

Recommended solder reflow for flex board:

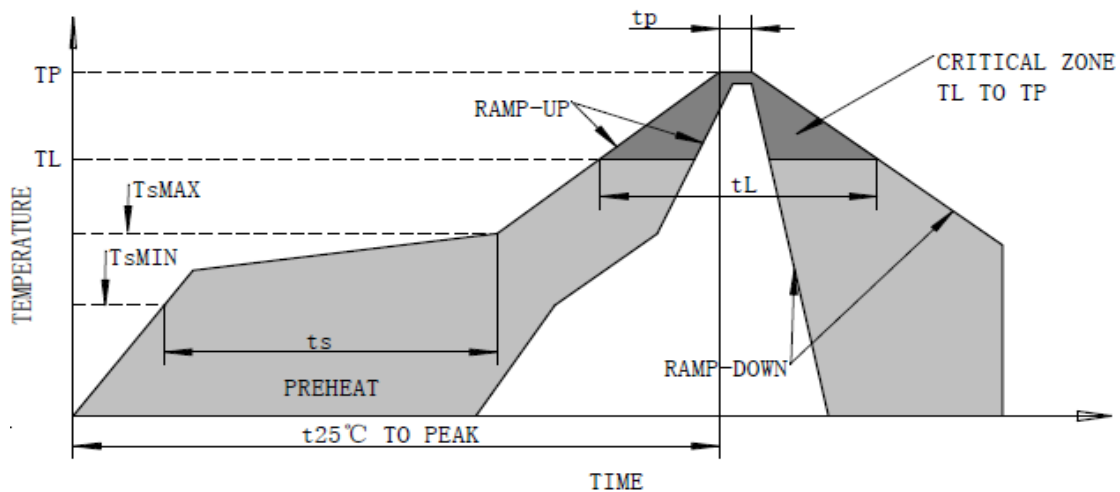

Profile Feature	Pb-Free Assembly
Average ramp-up rate(TsMAX to TP)	3°C/seconds max.
Preheat	
-Temperature Min.(TsMIN)	150°C
-Temperature Max.(TsMAX)	200°C
-Time(TsMIN to TsMAX)(Ts)	60~80seconds
Time maintained above:	
-Temperature(TL)	217°C
-Time(tL)	60~150seconds
Peak temperature(TP)	260°C
Time within 5°C of actual peak temperature(TP)2	20~40seconds
Ramp-down rate	4°C/seconds max.
Time 25°C to peak temperature	8 minutes max.

## 11. Package specifications

Carrier Tape Information [Unit: mm]

Quantity per reel: 3.0 k/pcs.

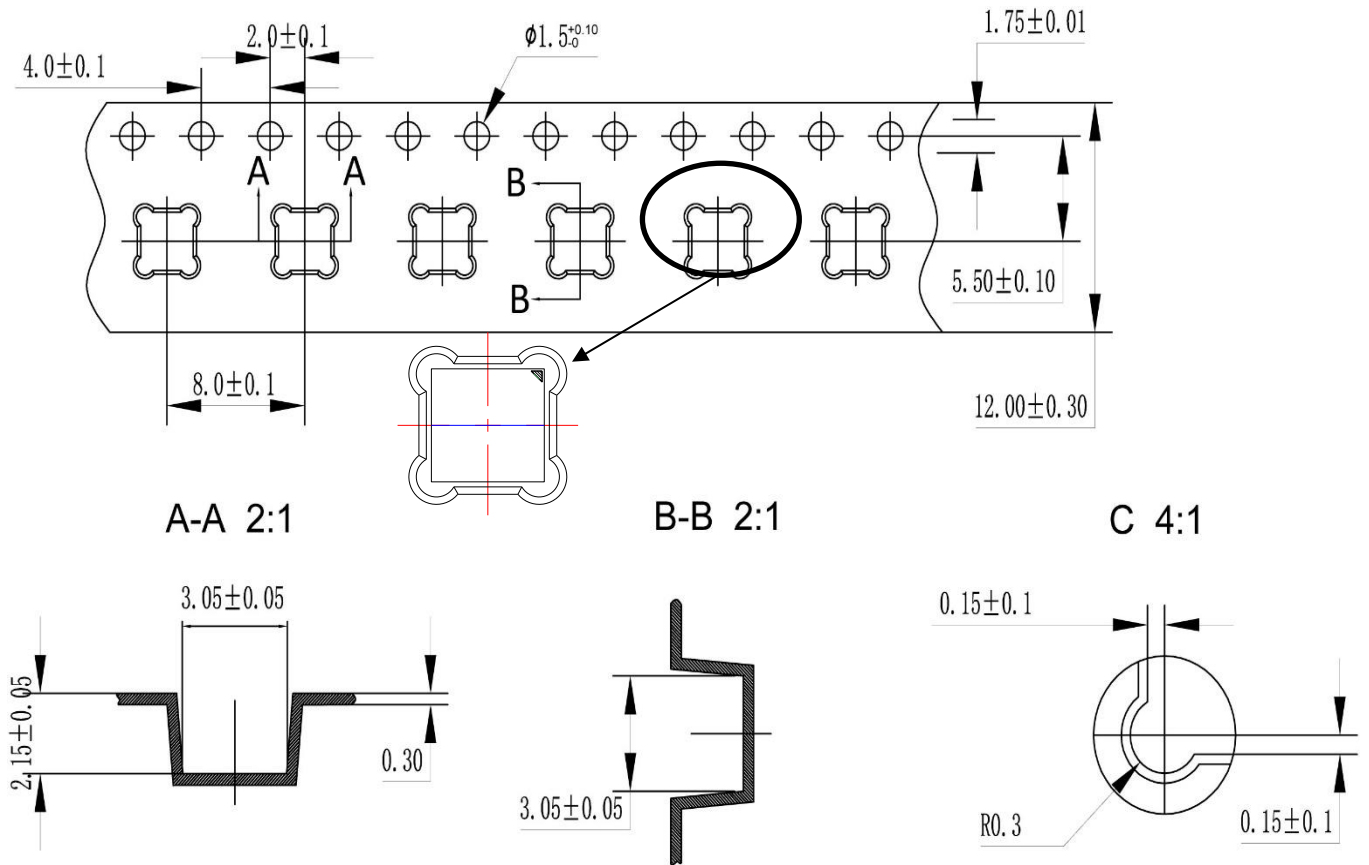

Figure 8: Carrier Tape

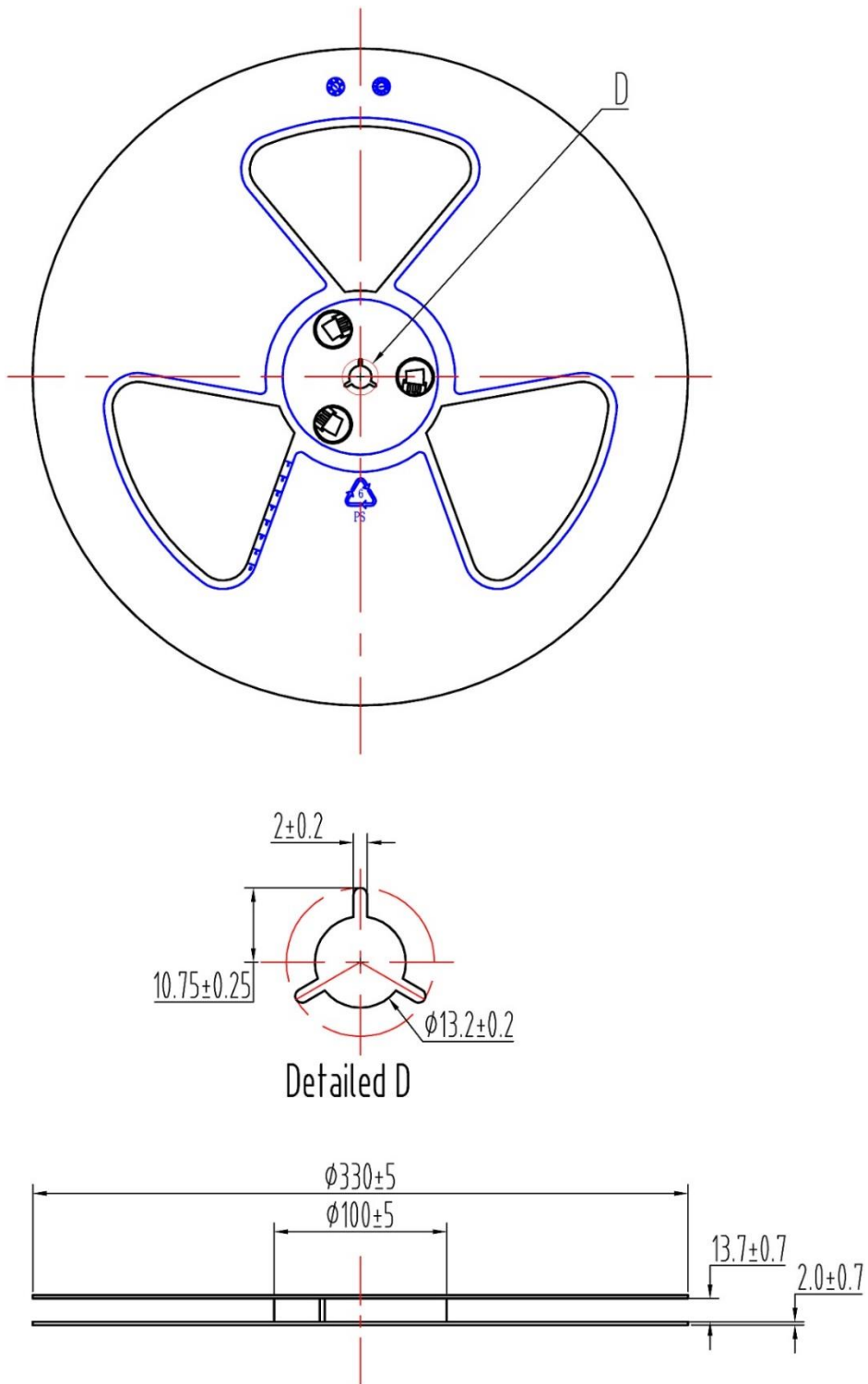

Figure 9: Carrier Tape (2)

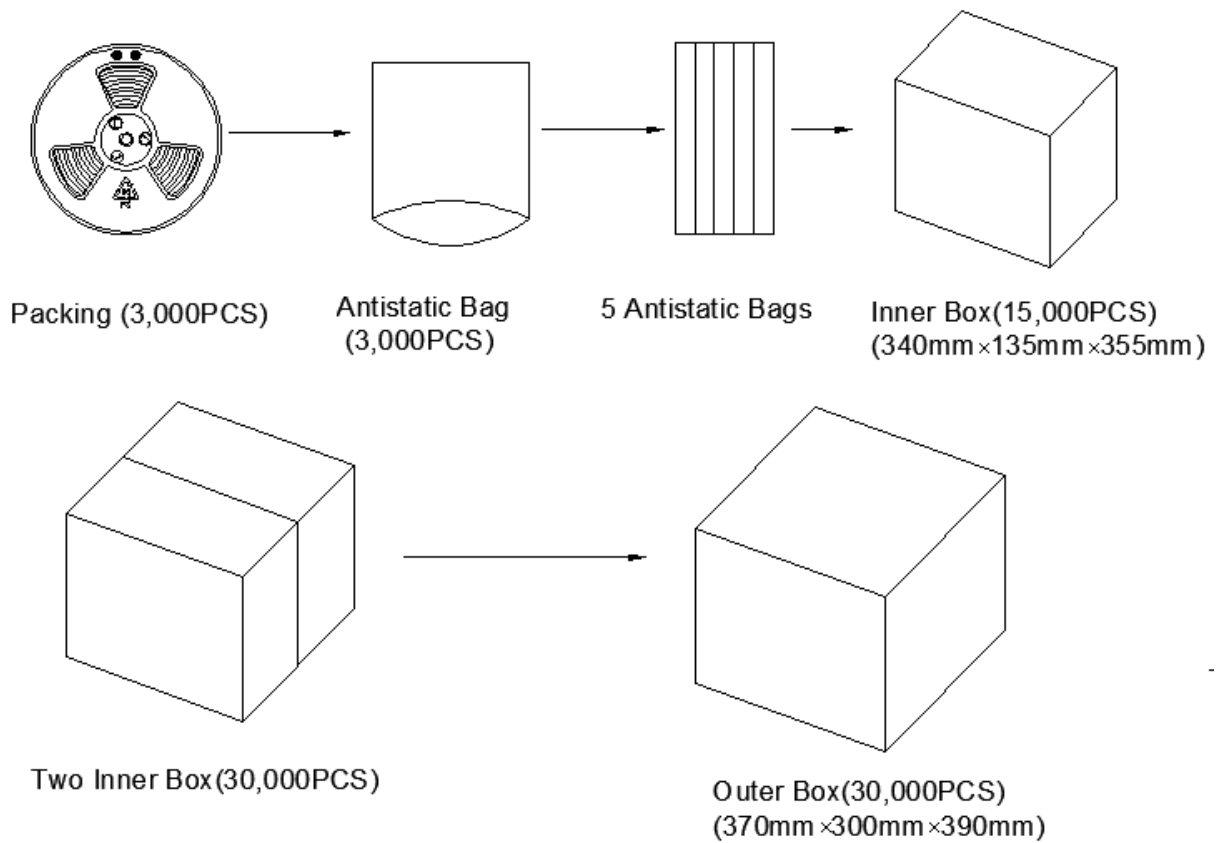

Figure 10: Packing Box

## 12. Reliability Specifications

NO.	Testing Item	Test Condition
1	High Temperature Storage	125°C,1000h (JESD22-A103)
2	High Temperature & Humidity Test	85°C, 85%R.H., 1000h, V=Vcc max (JESD22-A101)
3	Thermal Shock Test	-40°C/0.5 hours ~125°C/0.5 hours, 500 cycles (JESD22-A106)
4	Mechanical Shock Test	3000g,0.3ms,6axes*3 times (JESD22-B110)
5	Vibration Test	From 20 to 2000Hz peak acceleration 20g,16min/axis(4 cycles),X,Y and Z axis total 48 minutes (JESD22-B103)
6	HBM	±2KV,3 times for each pad (JESD22-A114)