

ITEM	Q'TY	PART NUMBER	PART DESCRIPTION
1	1	H-480C	Quad-Level 2X3mm LED Holder
2	4	R3XXX	2x3mm Rectangular LED

REV.	DESCRIPTION	DATE	APPROVED
C	Updated LED Protrusion	09/15/06	M. C.
D	Added P/N Designation Note	10/30/08	T. Y.
E	Added H480CRD Specs	12/04/08	T. Y.
F	Added All R3XXX LED Specs	08/01/11	T. Y.
G	Engineering Update w/o Changes	08/04/16	J. C.

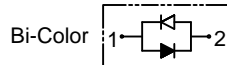

BI-COLOR POLARITY		
LED P/N	(1) CATHODE	(2) CATHODE
R3BC	GREEN	RED
R3BC-Y/G	GREEN	YELLOW

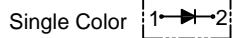
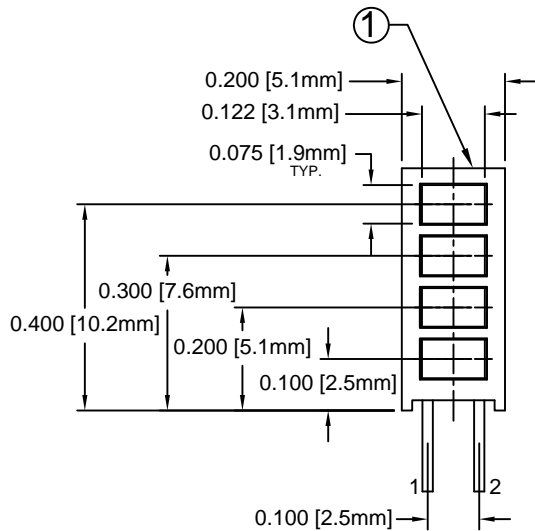
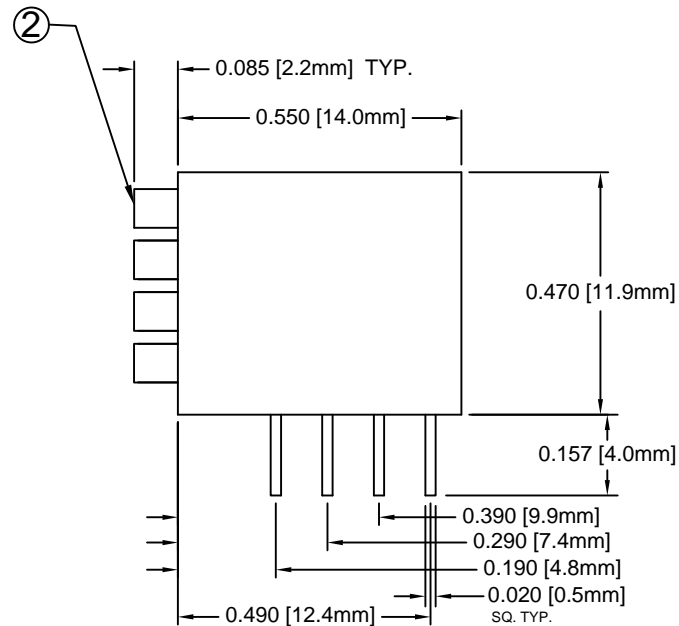
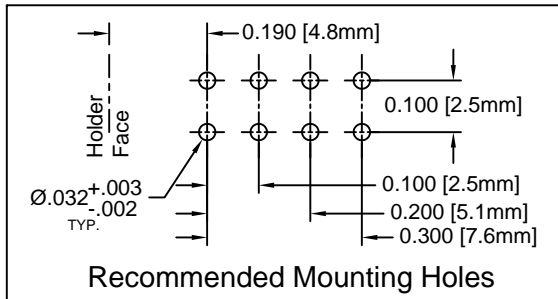

NOTE: P/N DESIGNATION

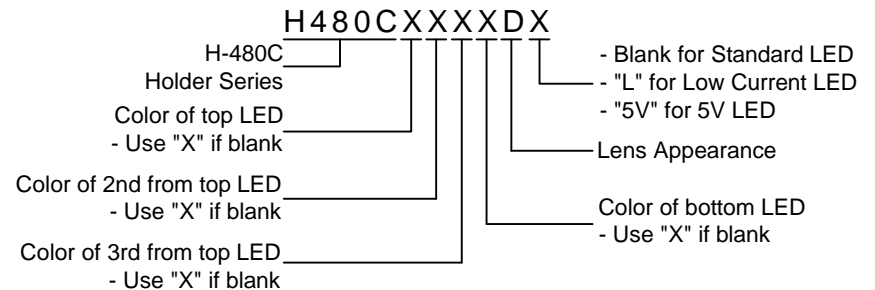

-If LEDs are the same, use e.g. H480CGD
All Green LEDs

ABSOLUTE MAXIMUM RATINGS (Ta=25° C)

REVERSE VOLTAGE	5V
REVERSE CURRENT	100uA
OPERATING TEMPERATURE RANGE	-25° C - 85° C
STORAGE TEMPERATURE	-30° C - 100° C
LEAD SOLDERING TEMPERATURE(1/16" FROM BODY)	260° C FOR 5 SECONDS

STANDARD TOLERANCE (UNLESS OTHERWISE SPECIFIED)		BIVAR®	
DECIMALS	ANGULAR	4 THOMAS, IRVINE, CA. 92618	
.X ± .1	X° ± 1°	TEL: (949) 951-8808 FAX: (949) 951-3974	
.XX ± .02		TITLE: RECTANGULAR 2X3MM 90° QUAD-LEVEL LED ASSEMBLY	
.XXX ± .010		PART NO: H480CXX	
DESIGNED: T. Yin	DATE: 03/08/04	REVISION: G	
CHECKED: D. Green	DATE: 03/08/04	CAGE CODE : 32559 SHEET # 1 OF 3	
CAD GENERATED DOCUMENT. DO NOT MEASURE DRAWING.			

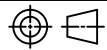

REV.	DESCRIPTION	DATE	APPROVED
	SEE SHEET #1		

LED Assy. No.	Peak Wave Length λ_p (nm)	Emitted Color	Lens Appearance	Electro-Optical Data				Viewing Angle $2\theta_{1/2}$ (Deg)	LED P/N
				If (mA)	Vf (V)		Iv (mcd)		
				TYP	TYP	MAX	TYP		
STANDARD				Data @ 20mA					
H480CAC	605	AMBER	WATER CLEAR	20	2.0	2.8	8.0	80	R3AC
H480CAD	605	AMBER	DIFFUSED	20	2.0	2.8	8.0	100	R3AD
H480CAT	605	AMBER	TINTED	20	2.0	2.8	8.0	80	R3AT
H480CBWD	430	BLUE	DIFFUSED	20	4.0	4.5	4.0	100	R3BWD
H480CGC	568	GREEN	WATER CLEAR	20	2.1	2.8	8.0	80	R3GC
H480CGD	568	GREEN	DIFFUSED	20	2.1	2.8	6.0	100	R3GD
H480CGT	568	GREEN	TINTED	20	2.1	2.8	8.0	80	R3GT
H480CYC	590	YELLOW	WATER CLEAR	20	2.0	2.8	6.0	80	R3YC
H480CYD	590	YELLOW	DIFFUSED	20	2.0	2.8	4.0	100	R3YD
H480CYT	590	YELLOW	TINTED	20	2.0	2.8	6.0	80	R3YT
H480CHC	625	HE RED	WATER CLEAR	20	2.0	2.8	8.0	80	R3HC
H480CHD	625	HE RED	DIFFUSED	20	2.0	2.8	6.0	100	R3HD
H480CHT	625	HE RED	TINTED	20	2.0	2.8	8.0	80	R3HT
H480CRC	700	RED	WATER CLEAR	20	2.1	2.8	1.0	80	R3RC
H480CRD	700	RED	DIFFUSED	20	2.1	2.8	0.5	100	R3RD
H480CRT	700	RED	TINTED	20	2.1	2.8	1.0	80	R3RT
H480CBC	625	RED	DIFFUSED	20	2.0	2.8	3.0	120	R3BC
	568	GREEN		20	2.1	2.8	2.5		
H480CBC-YG	590	YELLOW	DIFFUSED	20	2.0	2.8	2.5	120	R3BC-Y/G
	568	GREEN		20	2	2.8	2.5		

STANDARD TOLERANCE (UNLESS OTHERWISE SPECIFIED) $\pm 10\%$ ALL VALUES ANGULAR		 BIVAR [®] 4 THOMAS, IRVINE, CA. 92618 TEL: (949) 951-8808 FAX: (949) 951-3974	
			
DESIGNED: T. Yin	DATE: 03/08/04	TITLE: RECTANGULAR 2X3MM 90° QUAD-LEVEL LED ASSEMBLY	
CHECKED: D. Green	DATE: 03/08/04	PART NO: H480CXX	REVISION: G
		CAGE CODE : 32559	SHEET # 2 OF 3
CAD GENERATED DOCUMENT. DO NOT MEASURE DRAWING.			

REV.	DESCRIPTION	DATE	APPROVED
	SEE SHEET #1		

LED Assy. No.	Peak Wave Length λ_p (nm)	Emitted Color	Lens Appearance	Electro-Optical Data				Viewing Angle $2\theta \frac{1}{2}$ (Deg)	LED P/N
				If (mA)	Vf (V)		Iv (mcd)		
				TYP	TYP	MAX	TYP		
LOW CURRENT				Data @ 2mA					
H480CGDL	568	GREEN	DIFFUSED	2	2.1	2.8	0.4	100	R3GDL
H480CYDL	590	YELLOW	DIFFUSED	2	2.0	2.8	0.3	100	R3YDL
H480CHDL	625	HE RED	DIFFUSED	2	2.0	2.8	0.4	100	R3HDL
H480CRDL	700	RED	DIFFUSED	2	2.1	2.8	0.2	100	R3RDL
5 VOLT				Data @ 5V					
H480CAC5V	605	AMBER	CLEAR	8	-	5.0	8.0	80	R3AC5V
H480CAD5V	605	AMBER	DIFFUSED	8	-	5.0	6.0	100	R3AD5V
H480CAT5V	605	AMBER	TINTED	8	-	5.0	8.0	80	R3AT5V
H480CBWD5V	430	BLUE	DIFFUSED	8	-	5.0	4.0	100	R3BWD5V
H480CGC5V	568	GREEN	CLEAR	8	-	5.0	8.0	80	R3GC5V
H480CGD5V	568	GREEN	DIFFUSED	8	-	5.0	6.0	100	R3GD5V
H480CGT5V	568	GREEN	TINTED	8	-	5.0	8.0	100	R3GT5V
H480CYC5V	590	YELLOW	CLEAR	8	-	5.0	6.0	80	R3YC5V
H480CYD5V	590	YELLOW	DIFFUSED	8	-	5.0	4.0	100	R3YD5V
H480CYT5V	590	YELLOW	TINTED	8	-	5.0	6.0	80	R3YT5V
H480CHC5V	625	HE RED	CLEAR	8	-	5.0	8.0	80	R3HC5V
H480CHD5V	625	HE RED	DIFFUSED	8	-	5.0	6.0	100	R3HD5V
H480CHT5V	625	HE RED	TINTED	8	-	5.0	8.0	80	R3HT5V
H480CRC5V	700	RED	CLEAR	8	-	5.0	1.0	80	R3RC5V
H480CRD5V	700	RED	DIFFUSED	8	-	5.0	0.5	100	R3RD5V
H480CRT5V	700	RED	TINTED	8	-	5.0	1.0	80	R3RT5V

STANDARD TOLERANCE (UNLESS OTHERWISE SPECIFIED) $\pm 10\%$ ALL VALUES ANGULAR		 BIVAR [®] 4 THOMAS, IRVINE, CA. 92618 TEL: (949) 951-8808 FAX: (949) 951-3974	
			
DESIGNED: T. Yin	DATE: 03/08/04	PART NO: H480CXX	
CHECKED: D. Green	DATE: 03/08/04	REVISION: G CAGE CODE : 32559 SHEET # 3 OF 3	
CAD GENERATED DOCUMENT. DO NOT MEASURE DRAWING.			